



AESCULAP® SQ.line®
CATALOGUE

SO.line

Maillets	4-6
Osteotomes	5-8, 23
Gouges	9-10, 17
Ciseaux-Burins	11
Ciseaux-burin "swan neck" et instrument d'extraction de tiges prothétiques	12
Burins pour enlever le ciment	14-15
Extracteurs de ciment, crochets extracteur de ciment	16
Pinces à gouge	18-21
Pinces coupe os	22
Curettes	23-25
Rugines	26-28
Levier de luxation	29
Crochet à os, perceuse	30
Pointes balle	31
Aiguilles de guidage de fil	32
Pinces d'extraction pour fils	33
Pinces coupantes en métal dur	34
Pilons	35
Retracteur, lames de retractor	36



Les poids indiqués sont ceux de la tête de chaque maillet



1/2

FLO46211

Disque en métal, convexe, Ø 30 mm



1/2

FLO46212

Disque en matière plastique, convexe, Ø 30 mm



1/2

FLO46213

Disque en métal, plat, Ø 30 mm



1/2

FLO46214

Disque en matière plastique, plat, Ø 30 mm



330 g

Ø 30 mm

FLO46NR
AESCULAP®

1/2

FLO46NR 330 g

complet avec:
FLO46211 Disque en métal, convexe,
FLO46212 Disque en matière plastique, convexe
FLO62206 Clé
235 mm, 9 1/4"



380 g

Ø 34 mm

FLO57NR
AESCULAP®

1/2

FLO57NR 380 g

240 mm, 9 1/2"



580 g

Ø 40 mm

FLO66NR
AESCULAP®

1/2

FLO66NR 580 g

245 mm, 9 5/8"

Les poids indiqués sont ceux de la tête de chaque maillet



1/2

FL062211

Disque en métal,
convexe, Ø 35 mm



1/2

FL062212

Disque en matière
plastique, convexe,
Ø 35 mm



1/2

FL062213

Disque en métal, plat,
Ø 35 mm

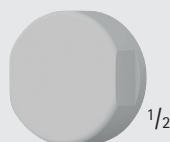

1/2

FL062214

Disque en matière
plastique, plat,
Ø 35 mm



WAGNER

FL062NR 530 g

Complet avec:

FL062211 Disque en métal, convexe

FL062212 Disque en matière plastique, convexe

FL062206 Clé

240 mm, 9 1/2"



FL062206

Clé
pour FL046NR et FL062NR
pour changer les disques



FL069NR 780 g

245 mm, 9 5/8"

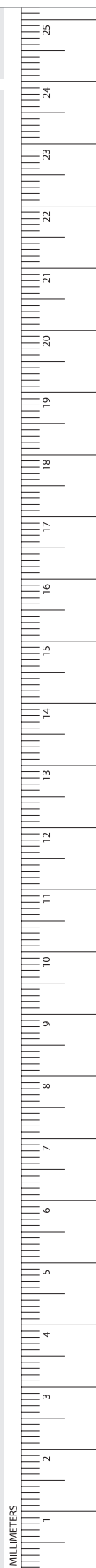

Les poids indiqués sont ceux de la tête de chaque maillet

INFO Box

Maillet avec fente KH113NR applicable avec extracteurs de ciment
 ND079-ND081R, ND089R 16
 crochets extrateur de ciment
 ND082R-ND084R 16



KH113NR 680 g
Maillet avec fente
280 mm, 11"



MB631NR 660 g
225 mm, 8 7/8"



LEXER

Art. Nr.	Largeur
FL400NR	4 mm
FL401NR	6 mm
FL402NR	8 mm
FL403NR	10 mm
FL405NR	15 mm
FL406NR	20 mm
FL407NR	25 mm
FL408NR	30 mm

240 mm, 9 1/2"

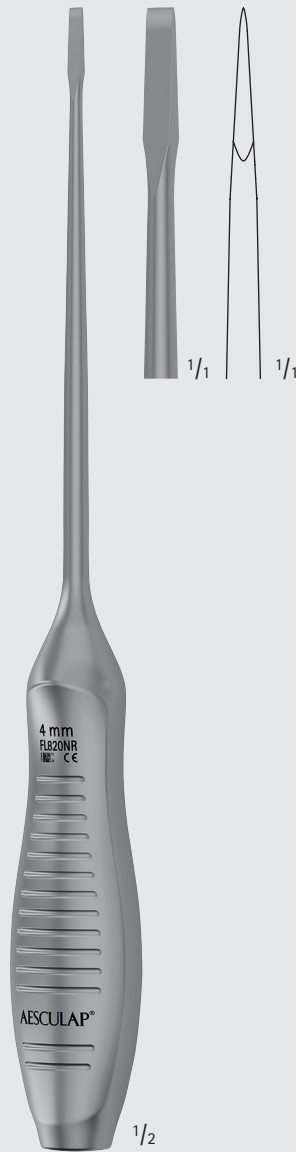

LEXER

Art. Nr.	Largeur
FL820NR	4 mm
FL821NR	6 mm
FL822NR	8 mm
FL823NR	10 mm
FL825NR	15 mm
FL826NR	20 mm
FL827NR	25 mm
FL828NR	30 mm

300 mm, 11 3/4"

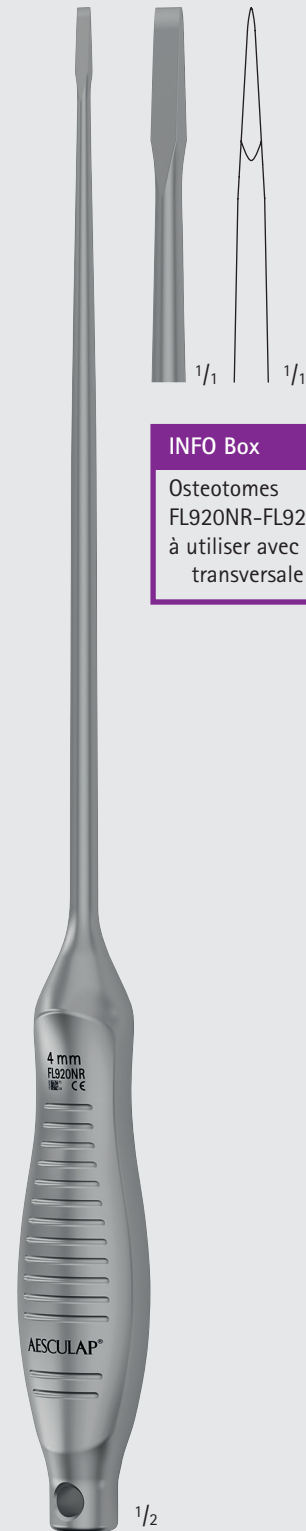

INFO Box

Osteotomes
FL920NR-FL927NR
à utiliser avec barre
transversale ND078R...15

LEXER

Art. Nr.	Largeur
FL920NR	4 mm
FL922NR	8 mm
FL925NR	15 mm
FL927NR	25 mm

400 mm, 15 3/4"

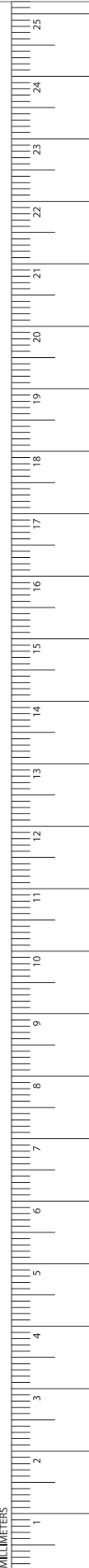

MILLIMETERS

SQ.line®
OSTEOTOMES

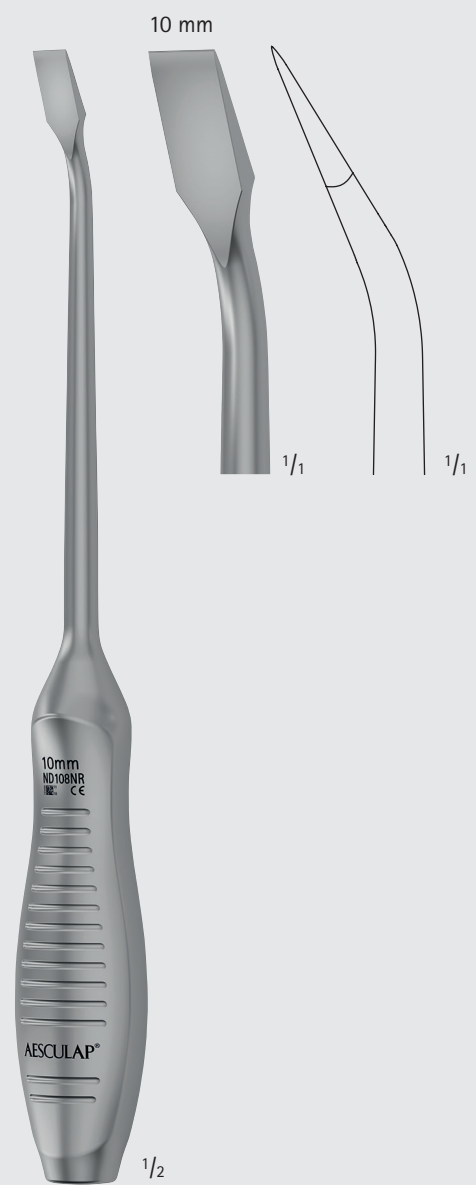
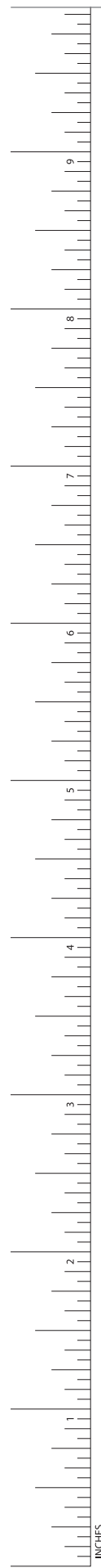

LEXER
ND108NR
Ostéotome coudé
300 mm, 11 3/4"



LEXER
ND109NR
Ostéotome coudé
300 mm, 11 3/4"



LEXER

Art. Nr.	Largeur
FL410NR	4 mm
FL411NR	6 mm
FL412NR	8 mm
FL413NR	10 mm
FL415NR	15 mm
FL416NR	20 mm
FL417NR	25 mm
FL418NR	30 mm

240 mm, 9 1/2"

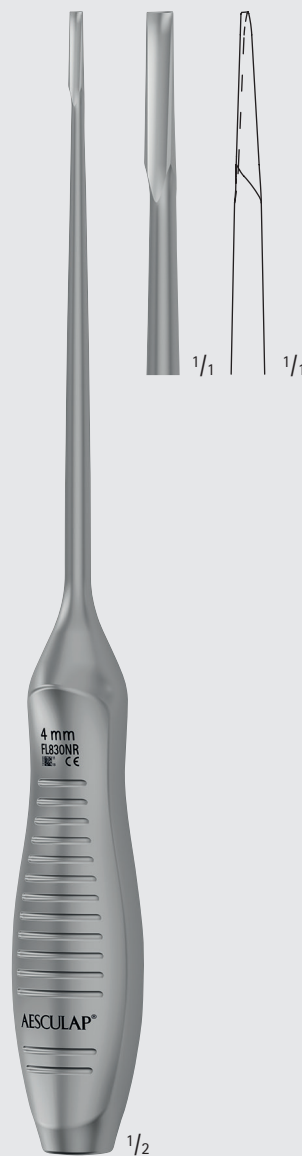

LEXER

Art. Nr.	Largeur
FL830NR	4 mm
FL831NR	6 mm
FL832NR	8 mm
FL833NR	10 mm
FL835NR	15 mm
FL836NR	20 mm
FL837NR	25 mm
FL838NR	30 mm

300 mm, 11 3/4"

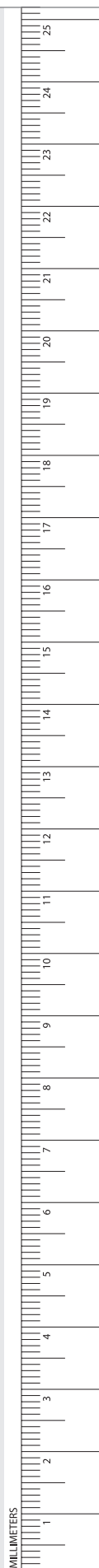

INFO Box

Gouges FL930NR-FL937NR
à utiliser avec barre
transversale ND078R15

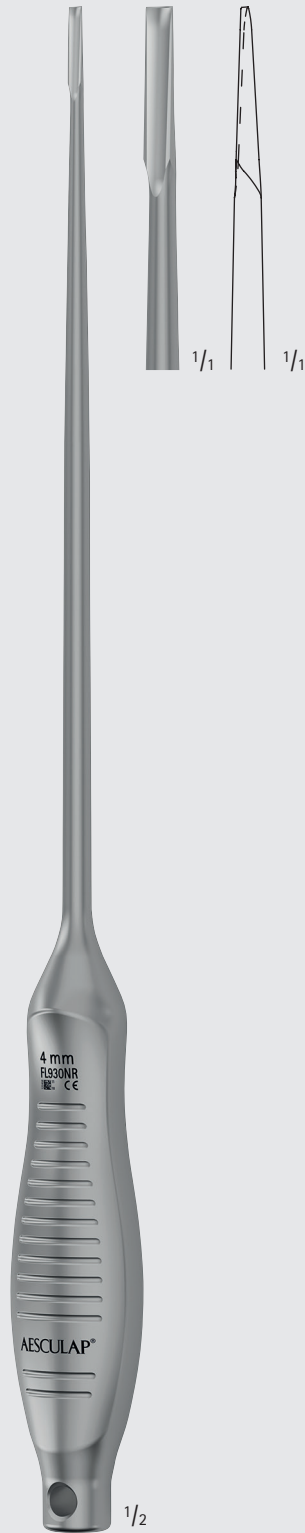

LEXER

Art. Nr.	Largeur
FL930NR	4 mm
FL932NR	8 mm
FL935NR	15 mm
FL937NR	25 mm
400 mm, 15 3/4"	



Art. Nr.	Largeur
FL441NR	5 mm
FL443NR	10 mm
FL445NR	15 mm

Gouges d'os spongieux, courbées
240 mm, 9 1/2"

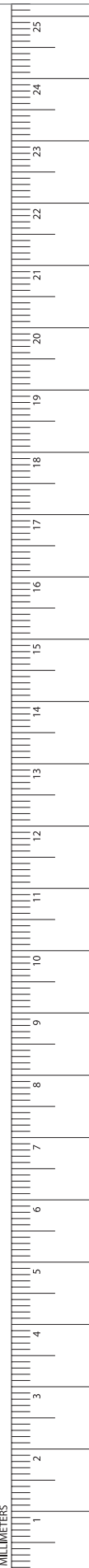
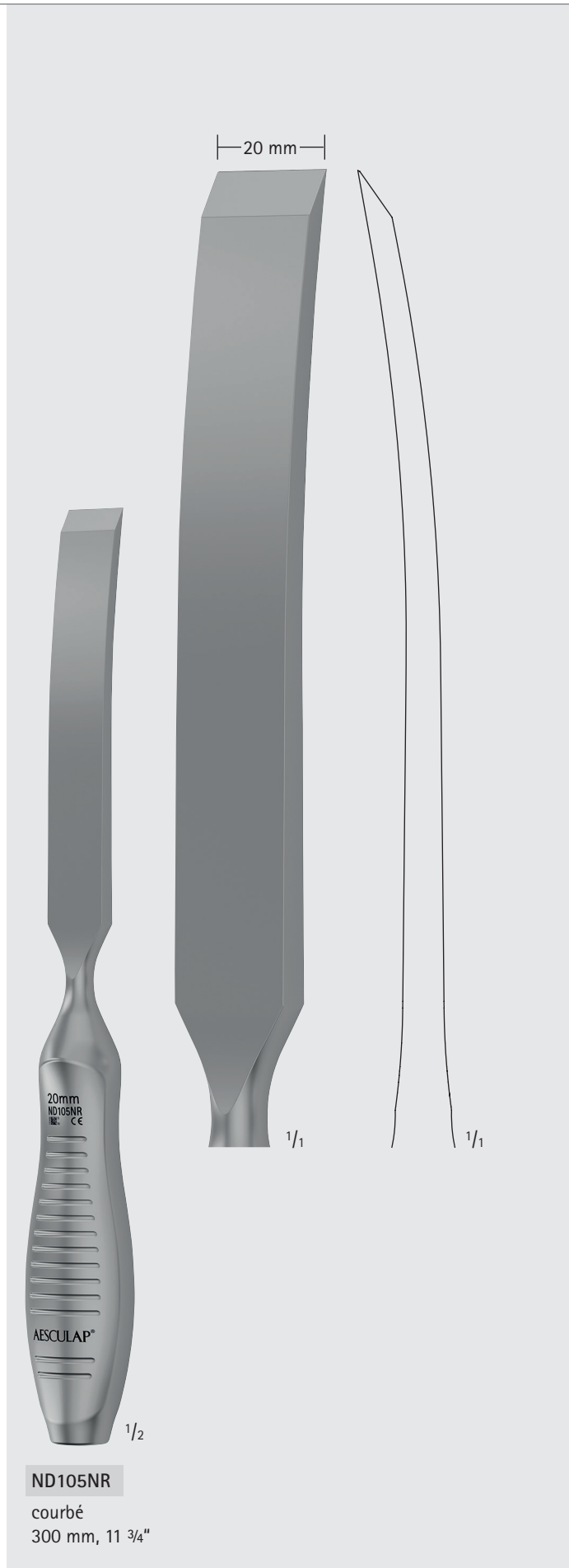
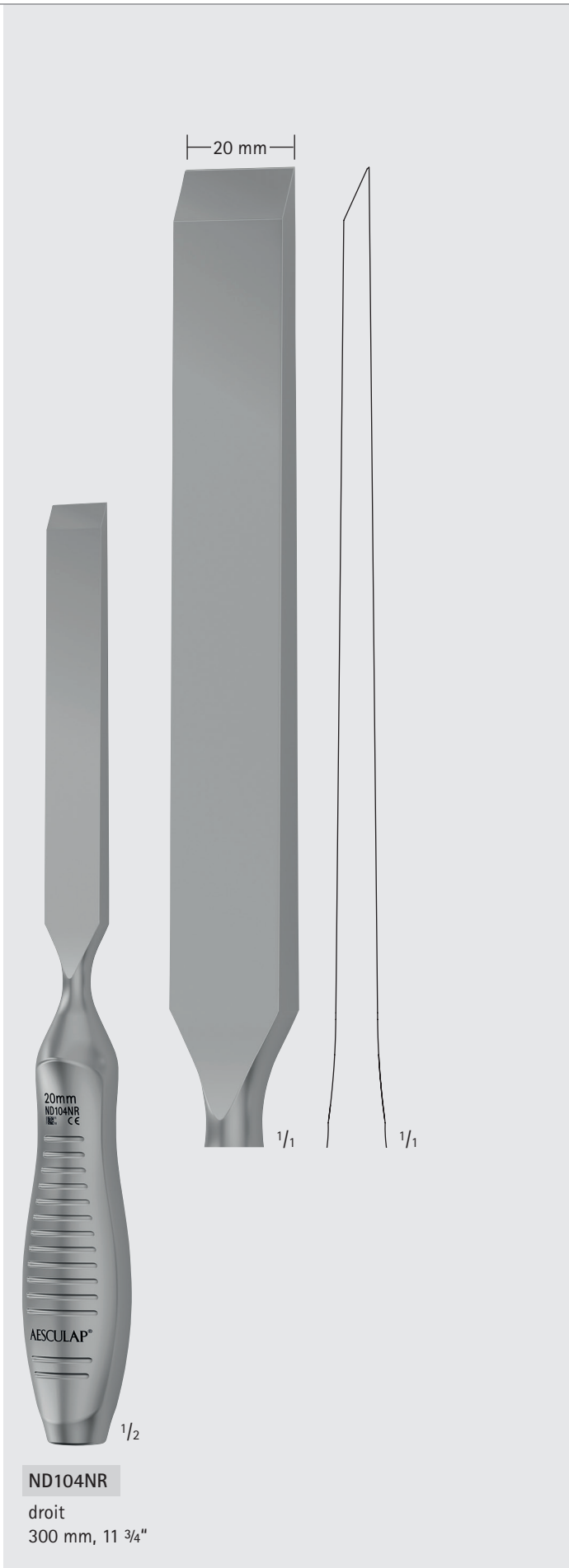

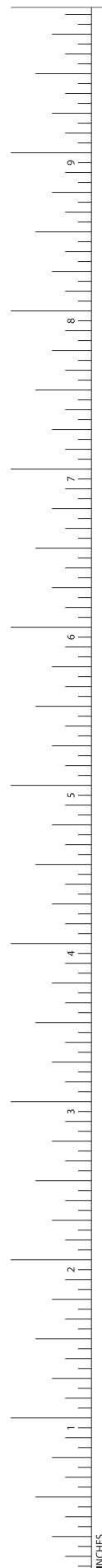

ND118NR

Ciseaux-Burin "Swan neck*"
300 mm, 11 3/4"

* Col de cygne

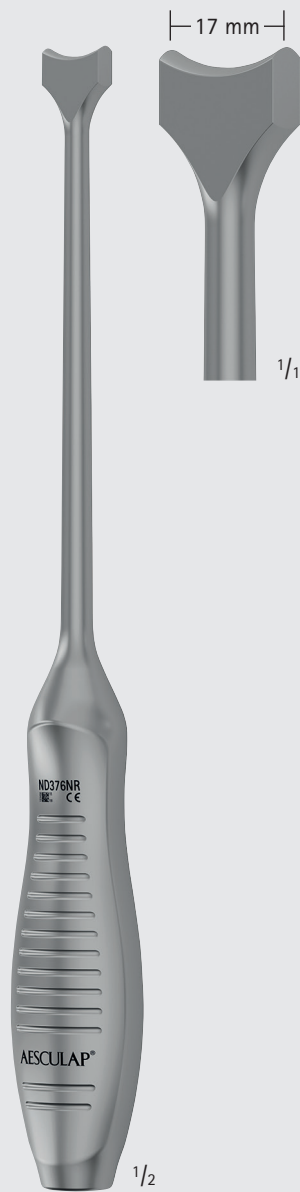

ND376NR

Instrument d'extraction pour tiges prothétiques
300 mm, 11 3/4"

INFO Box

Gouges ND091NR-ND098NR à utiliser
avec la barre transversale
ND078R15

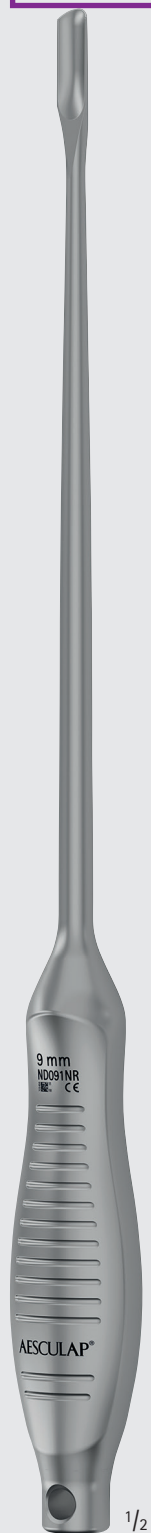

WAGNER

ND091NR-ND098NR

400 mm, 15 3/4"

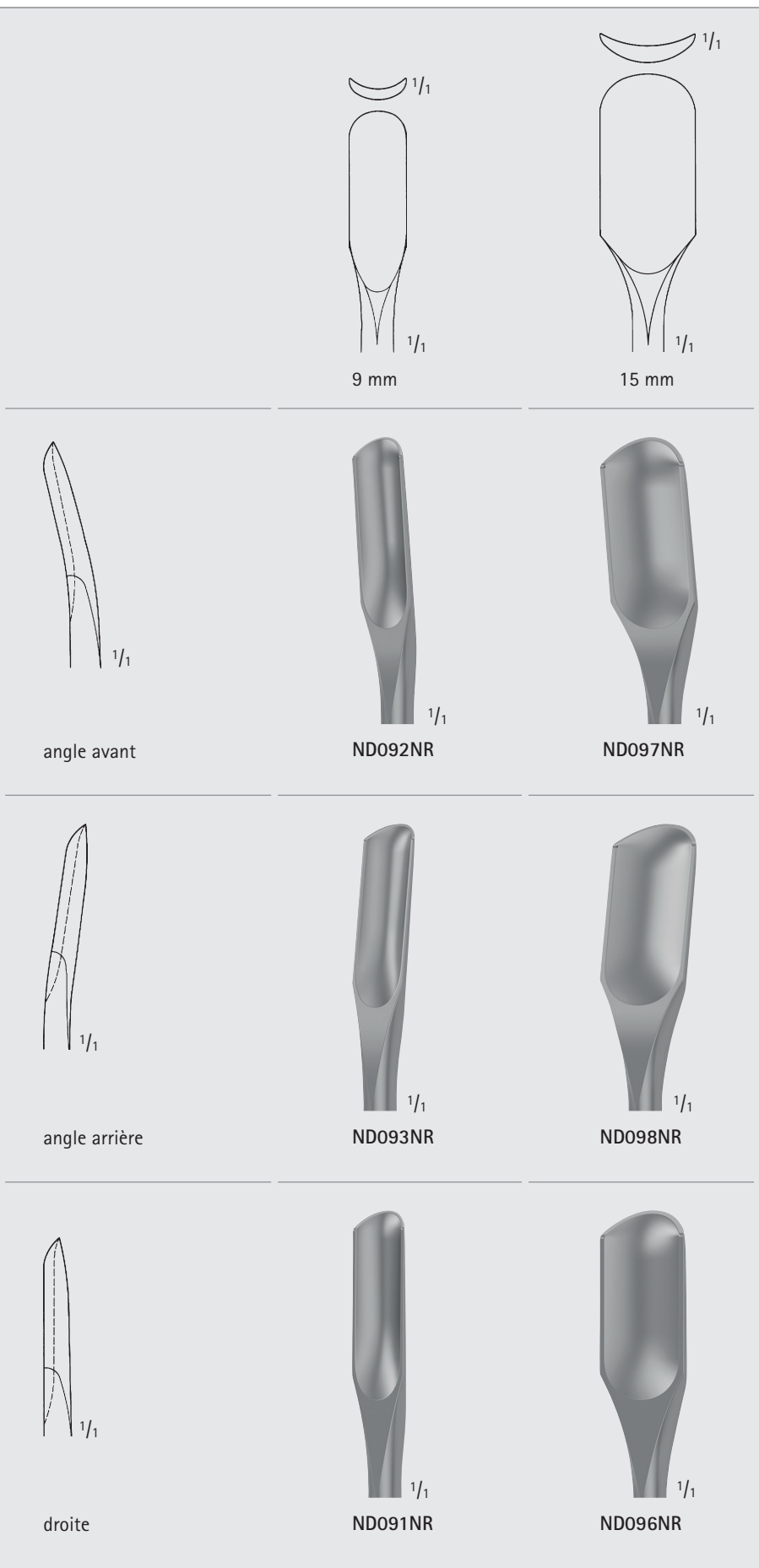

9 mm

15 mm

angle avant

ND092NR

ND097NR

angle arrière

ND093NR

ND098NR

droite

ND091NR

ND096NR



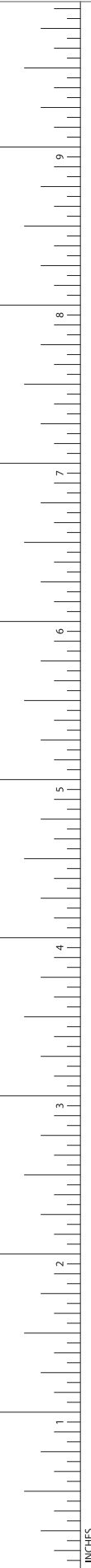

INFO Box
 Burins ND066NR-ND068NR
 à utiliser avec la barre
 transversale ND078R 15

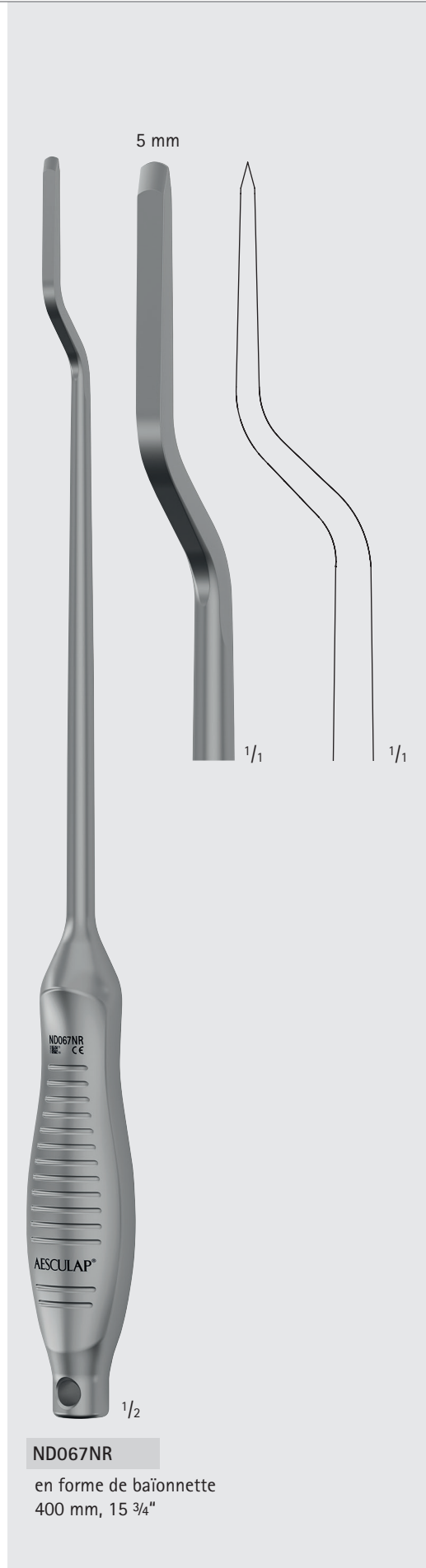
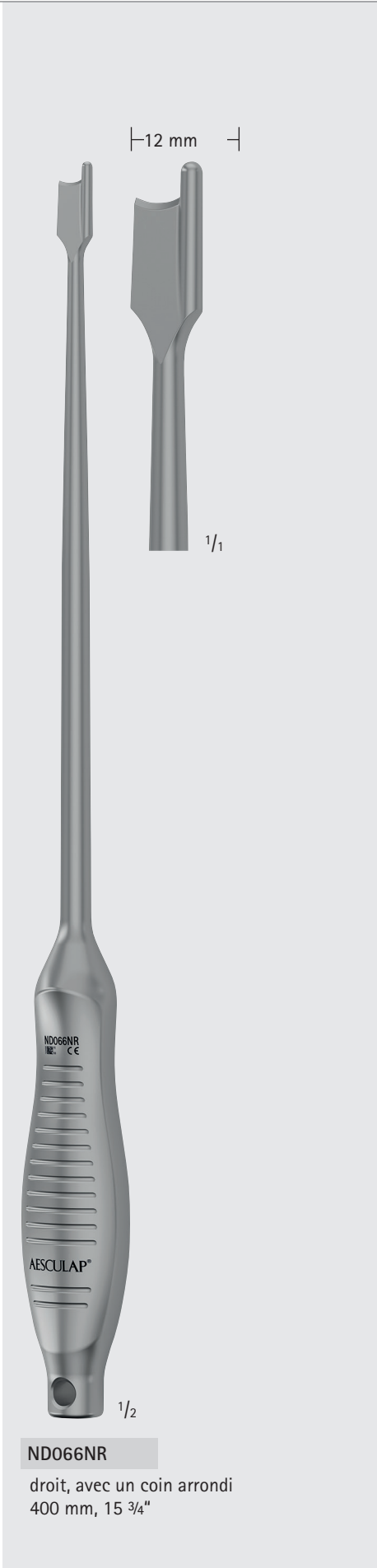

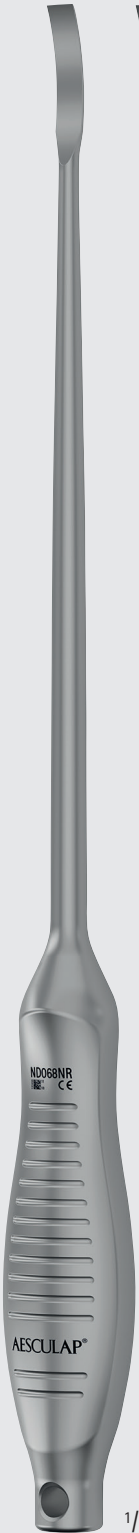
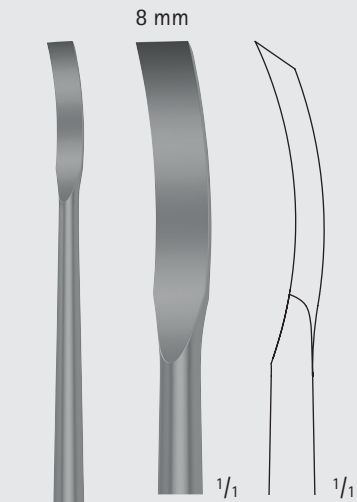

ND068NR
courbé
400 mm, 15 3/4"

INFO Box

Barre transversale ND078R pour utilisation avec ostéotomes FL920NR-FL927NR7

Avec burins:

FL930NR-FL937NR 10

ND066NR-ND068NR 14, 15

ND091NR-ND098NR 13



ND078R
Barre transversale
110 mm, 4 1/4"

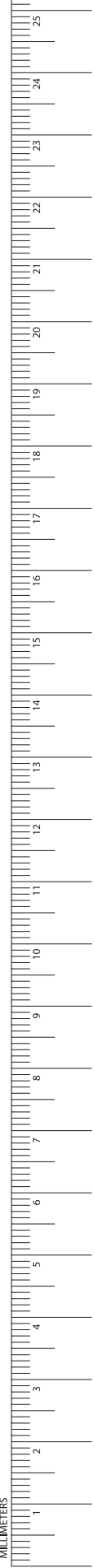

INFO Box

Maillet avec fente
 KH113NR 6
 à utiliser avec extracteurs de ciment
 ND079-ND081R,ND089R
 et crochets extracteur de ciment
 ND082R-ND084R

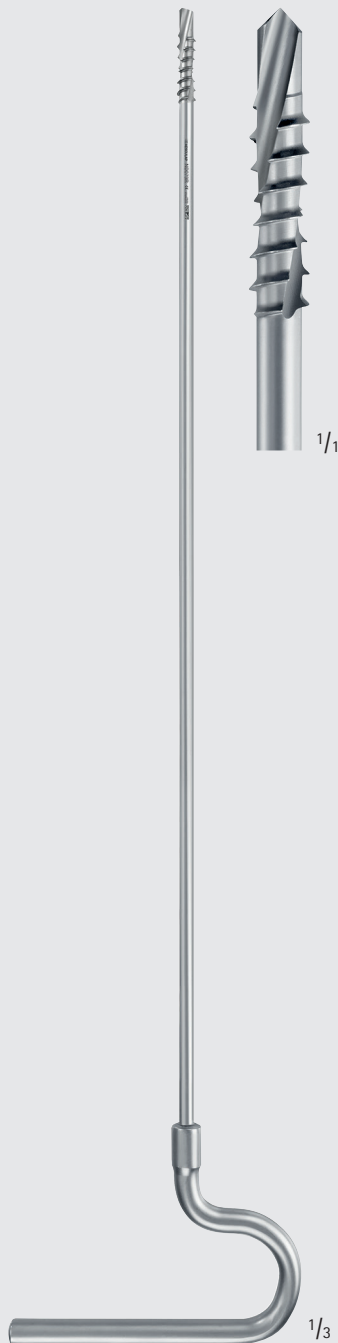

Art. Nr.	Ø de la pointe	Tige-Ø
ND079R	8 mm	6 mm
ND080R	10 mm	6 mm
ND081R	12 mm	6 mm
ND089R	14 mm	6 mm

Extracteurs de ciment filetés
 525 mm, 20 3/4"



Art. Nr.	largeur de la lame	Tige-Ø
ND082R	6 mm	6 mm
ND083R	8 mm	6 mm
ND084R	10 mm	6 mm

Crochets extracteur de ciment
 530 mm, 20 7/8"

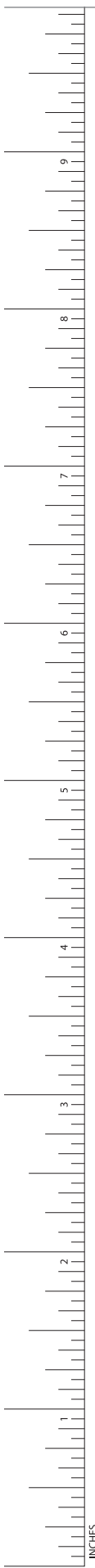

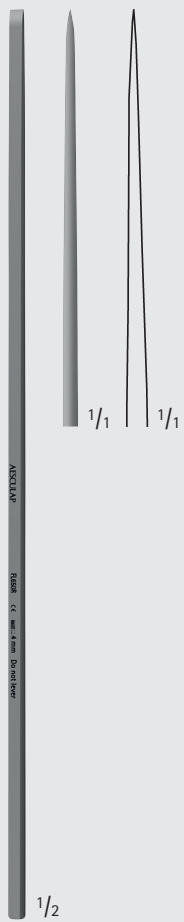

LAMBOTTE

Art. Nr.	Largeur
FL650R	4 mm
FL663R	6 mm
FL651R	8 mm
FL652R	10 mm
FL653R	13 mm
FL654R	15 mm
FL655R	18 mm
FL656R	20 mm
FL658R	25 mm
FL659R	30 mm
FL660R	40 mm
FL662R	50 mm

droits
240 mm, 9 1/2"



LAMBOTTE

Art. Nr.	largeur
FL800R	4 mm
FL813R	6 mm
FL801R	8 mm
FL802R	10 mm
FL804R	15 mm
FL806R	20 mm
FL808R	25 mm
FL809R	30 mm
FL810R	40 mm
FL812R	50 mm

droits
300 mm, 11 3/4"

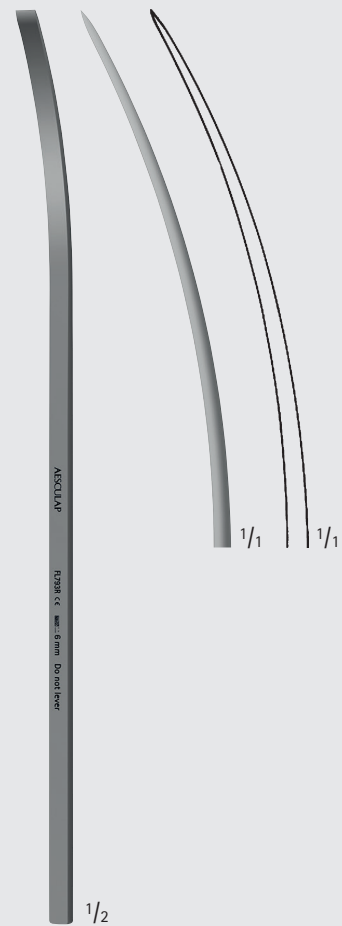

LAMBOTTE

Art. Nr.	Largeur
FL793R	6 mm
FL781R	8 mm
FL782R	10 mm
FL783R	15 mm
FL785R	20 mm
FL788R	25 mm
FL789R	30 mm
FL790R	40 mm

courbés
240 mm, 9 1/2"

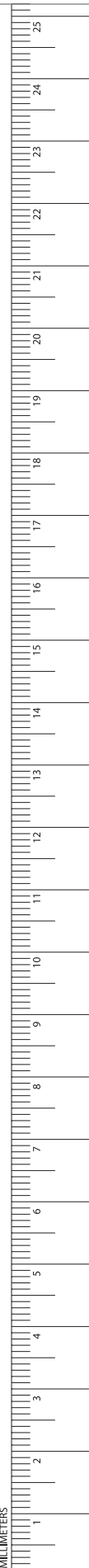

SQ.line®
PINCES À GOUGE

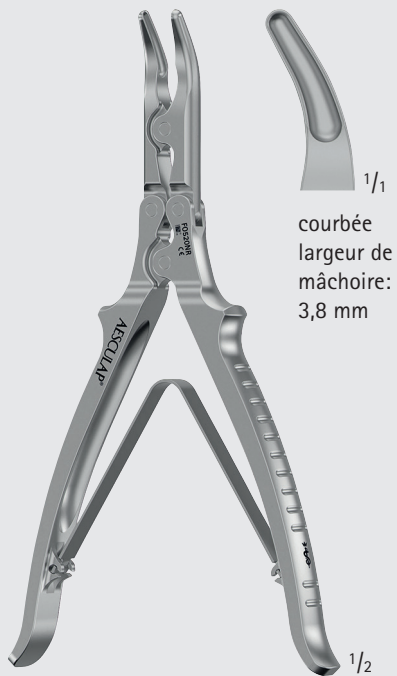

$\frac{1}{1}$
courbée
largeur de
mâchoire:
3,8 mm

LUER
FO520NR
180 mm, 7"

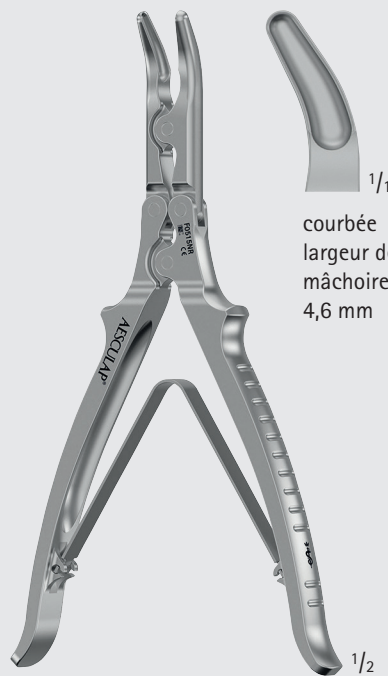

$\frac{1}{1}$
courbée
largeur de
mâchoire:
4,6 mm

LUER
FO515NR
180 mm, 7"

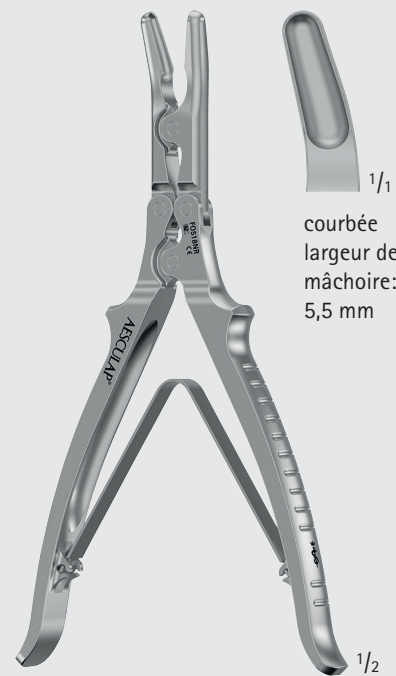

$\frac{1}{1}$
courbée
largeur de
mâchoire:
5,5 mm

LUER
FO518NR
180 mm, 7"

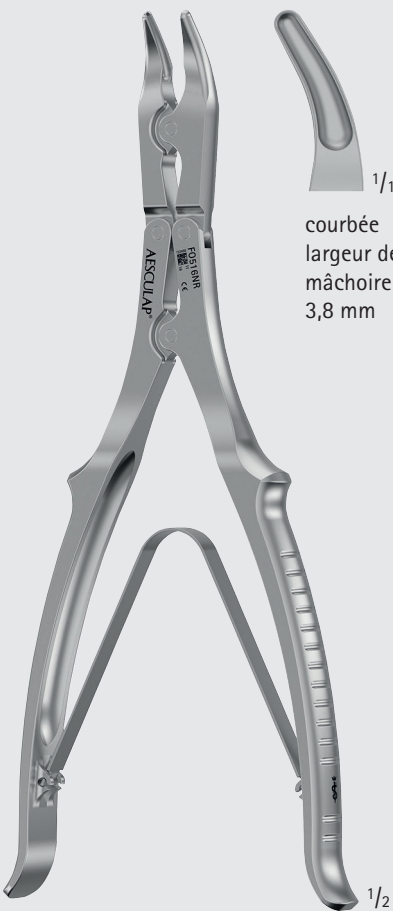
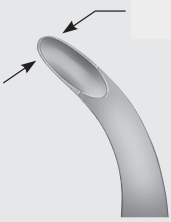

courbée
largeur de
mâchoire:
3,8 mm

LUER
FO516NR
240 mm, 9 1/2"

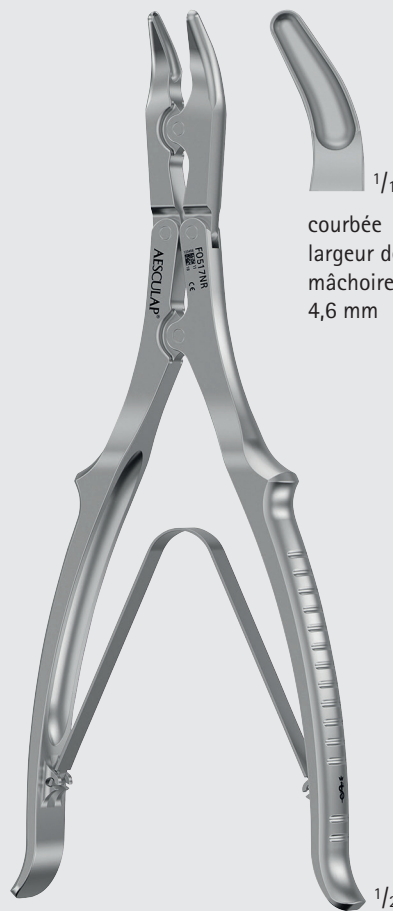

courbée
largeur de
mâchoire:
4,6 mm

LUER
FO517NR
240 mm, 9 1/2"

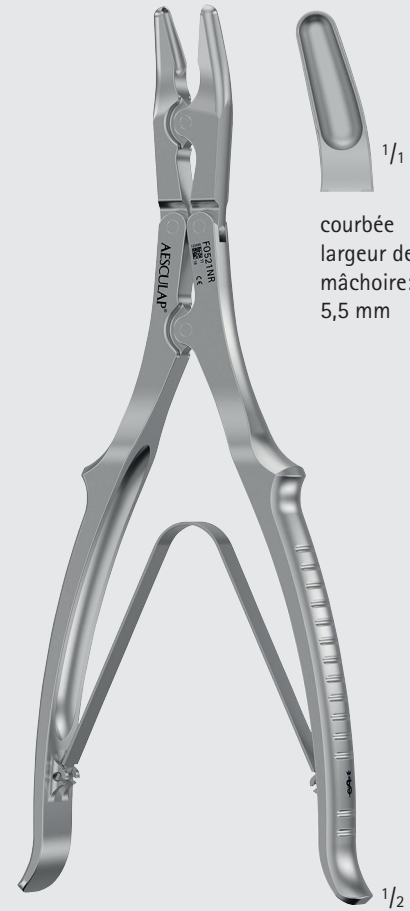

courbée
largeur de
mâchoire:
5,5 mm

LUER
FO521NR
240 mm, 9 1/2"

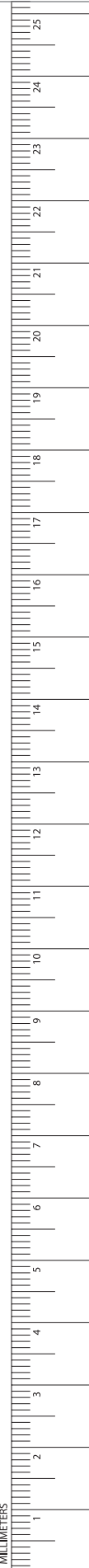

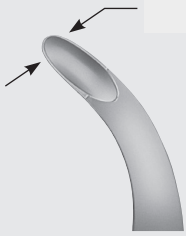

de côté
incliné
largeur de
mâchoire:
6,8 mm

LUER-STILLE
FO530NR
240 mm, 9 1/2"

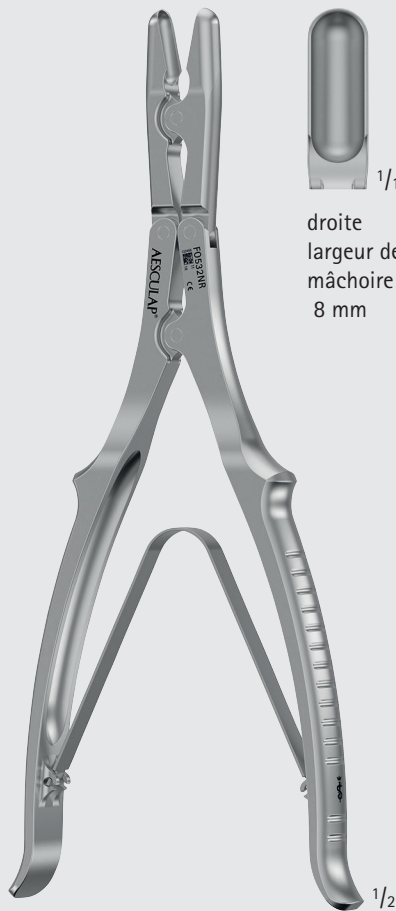

droite
largeur de
mâchoire:
8 mm

LUER-STILLE
FO532NR
240 mm, 9 1/2"



courbée
largeur de
mâchoire:
8 mm

LUER-STILLE
FO534NR
240 mm, 9 1/2"

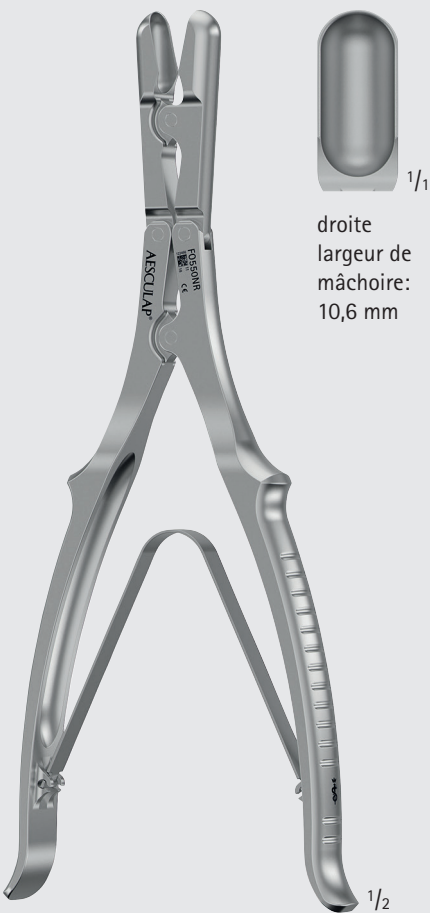
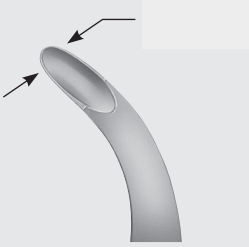

droite
 largeur de
 mâchoire:
 10,6 mm

LUER-STILLE
FO550NR
 240 mm, 9 1/2"

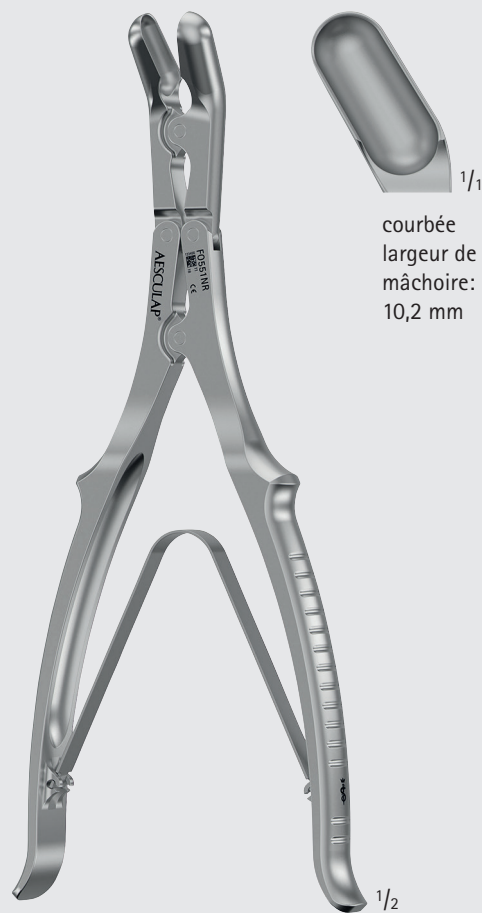

courbée
 largeur de
 mâchoire:
 10,2 mm

LUER-STILLE
FO551NR
 240 mm, 9 1/2"

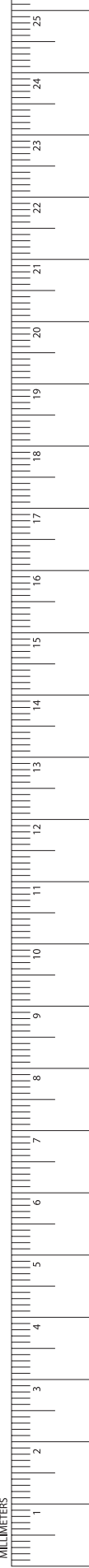

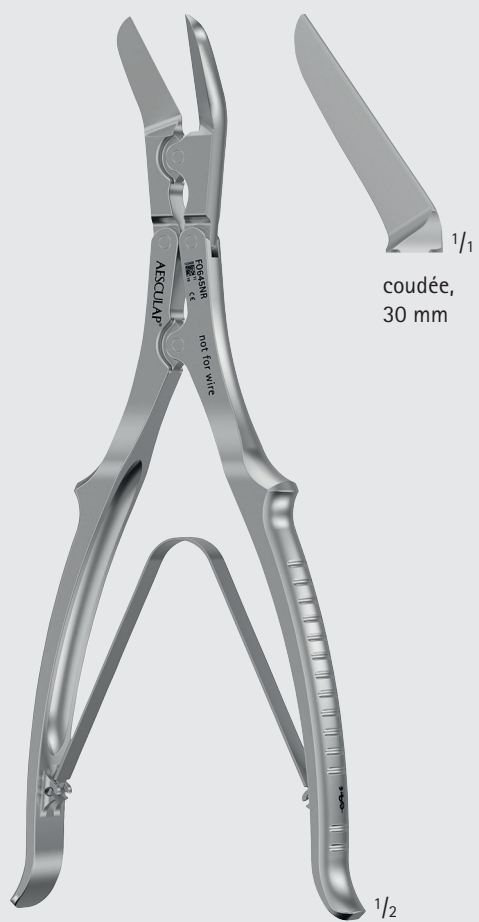

LISTON
FO645NR
240 mm, 9 1/2"

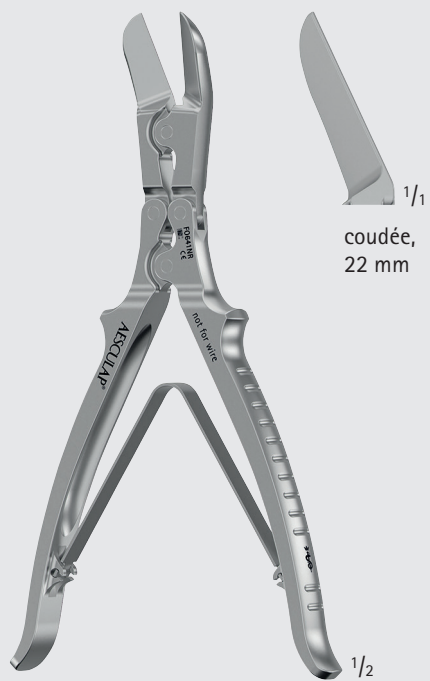

RUSKIN-LISTON
FO641NR
180 mm, 7"

2,8 mm



FK630NR

3,6 mm



FK631NR

4,4 mm



FK632NR

5,2 mm



FK633NR

6,8 mm



FK634NR

8,5 mm



FK635NR

10 mm



FK636NR

11,5 mm



FK637NR

13 mm



FK638NR

14,5 mm



FK639NR



VOLKMANN

FK630NR-FK639NR

180 mm, 7"

2,8 mm



FK640NR

3,6 mm



FK641NR

4,4 mm



FK642NR

5,2 mm



FK643NR

6,8 mm



FK644NR

8,5 mm



FK645NR

10 mm



FK646NR

11,5 mm



FK647NR

13 mm



FK648NR

14,5 mm



FK649NR



VOLKMANN

FK640NR-FK649NR

240 mm, 9 1/2"

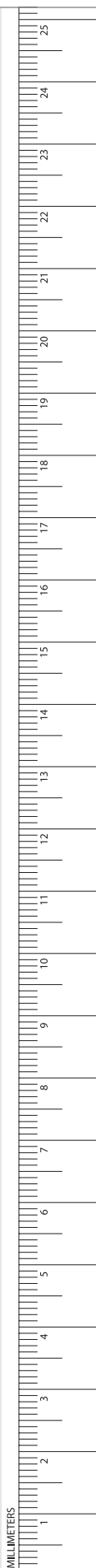

SQ.line®
CURETTES

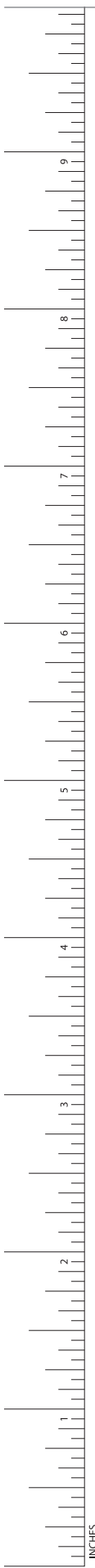

5.2mm
FK743NR
AESCULAP®
CE

VOLKMANN
FK743NR-FK747NR
300 mm, 11 3/4"

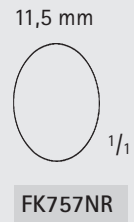

5.2mm
FK753NR
AESCULAP®
CE

VOLKMANN
FK753NR-FK757NR
400 mm, 15 3/4"

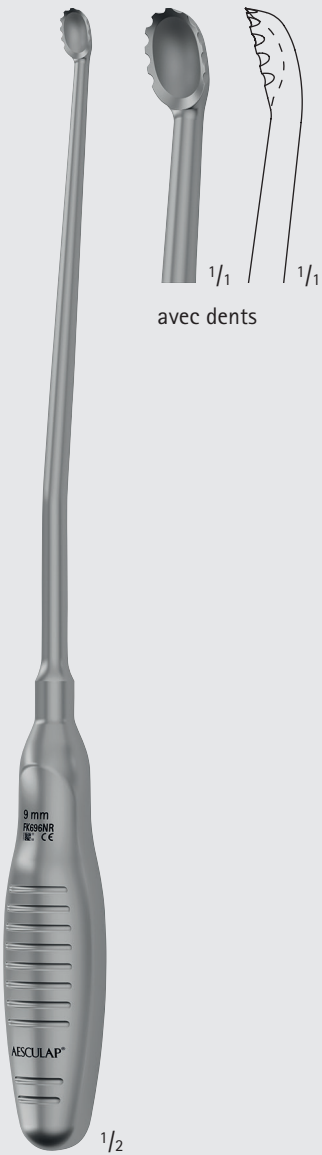

avec dents

Art. Nr.	Largeur
FK696NR	9 mm
FK698NR	15 mm
300 mm, 11 3/4"	

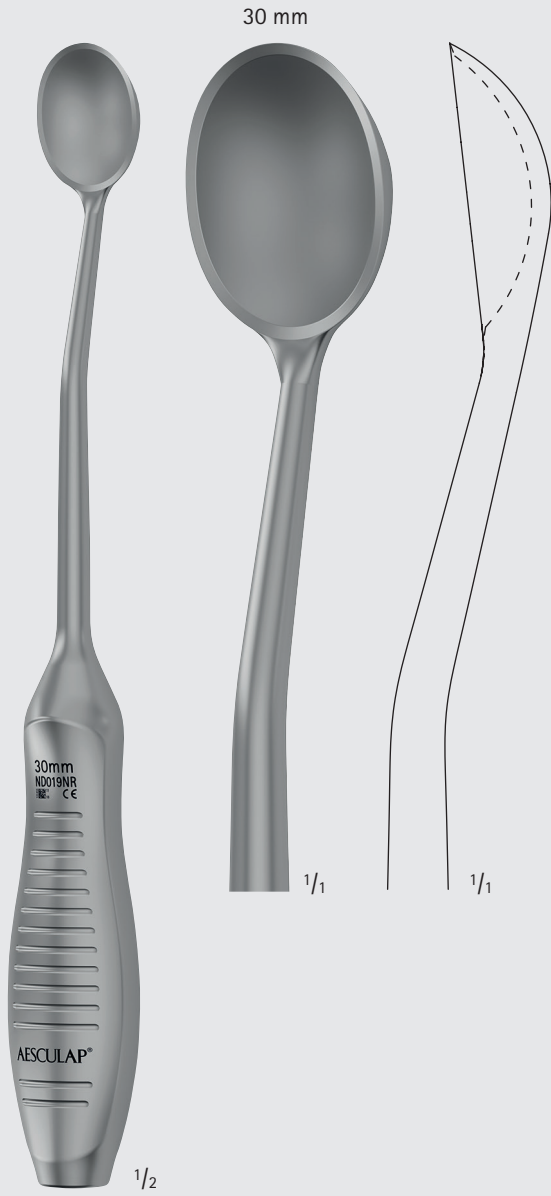

30 mm

ND019NR
300 mm, 11 3/4"

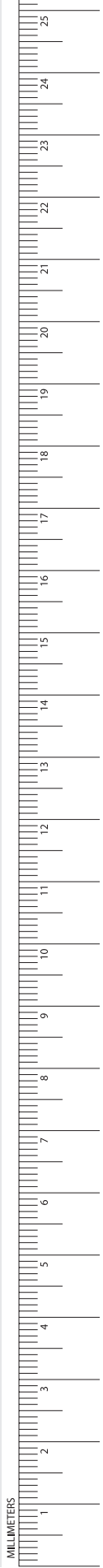

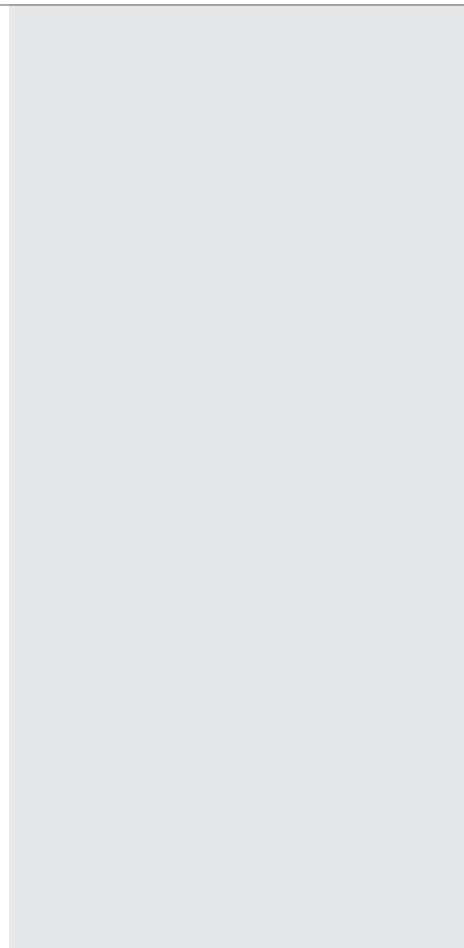
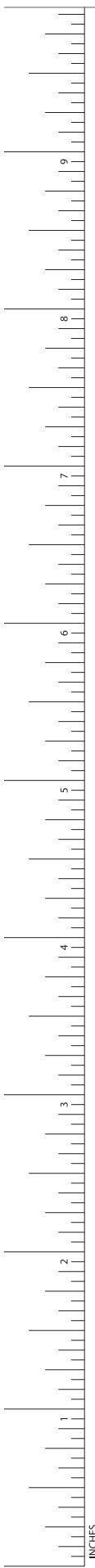

3 mm

1/1 1/1

courbée, angulaire

3 mm
FK317NR
N° CÉ

AESCLAP®

1/2

FK317NR
200 mm, 7 7/8"

3 mm

1/1 1/1

courbée, ronde

3 mm
FK316NR
N° CÉ

AESCLAP®

1/2

FK316NR
200 mm, 7 7/8"

6 mm

1/1 1/1

droite, angulaire

6 mm
FK318NR
N° CÉ

AESCLAP®

1/2

FK318NR
200 mm, 7 7/8"

6 mm

1/1 1/1

courbée, angulaire

6 mm
FK319NR
N° CÉ

AESCLAP®

1/2

FK319NR
200 mm, 7 7/8"

6 mm

1/1 7/8/1

courbée, ronde

6 mm
FK321NR
N° CÉ

AESCLAP®

1/2

FK321NR
200 mm, 7 7/8"

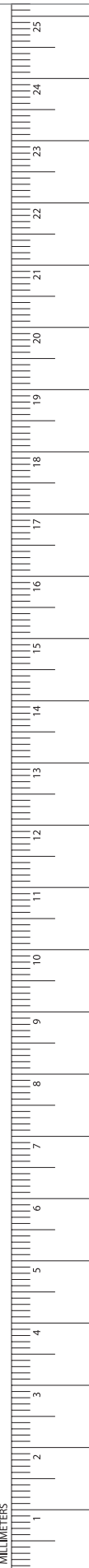
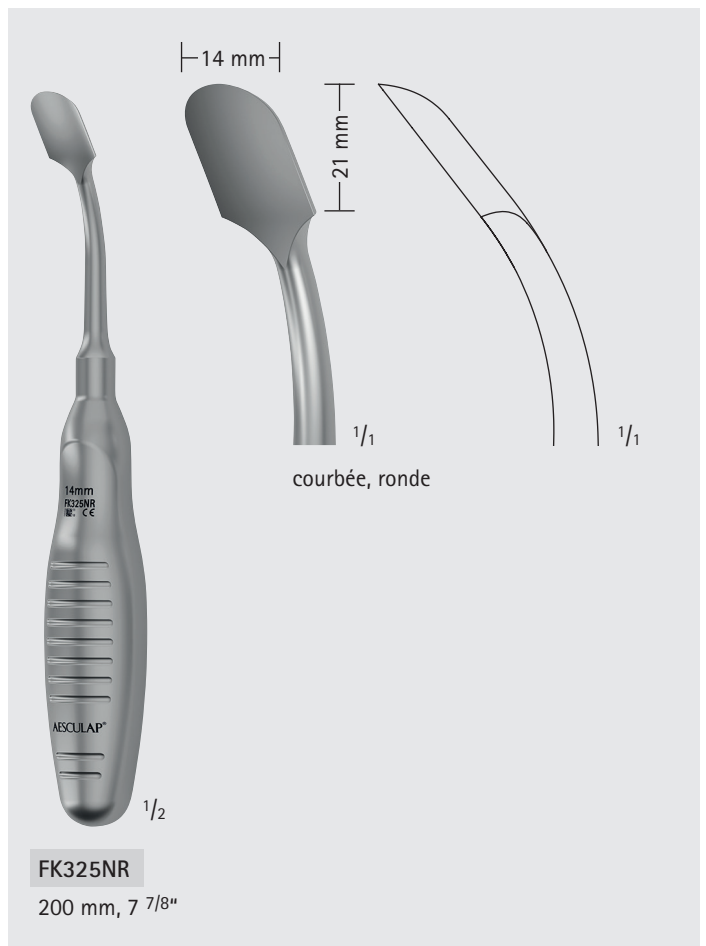
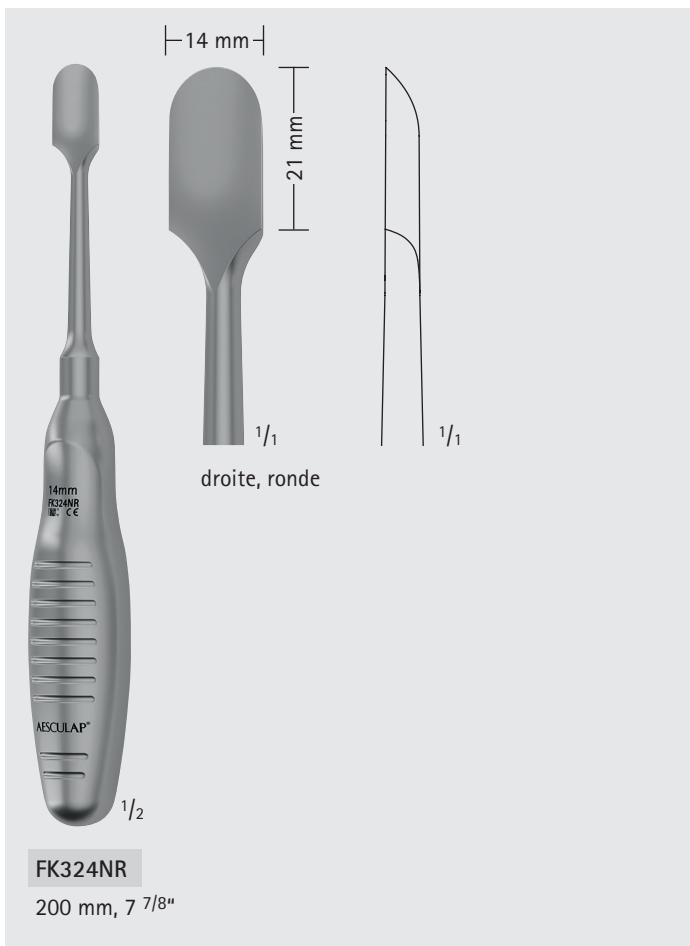
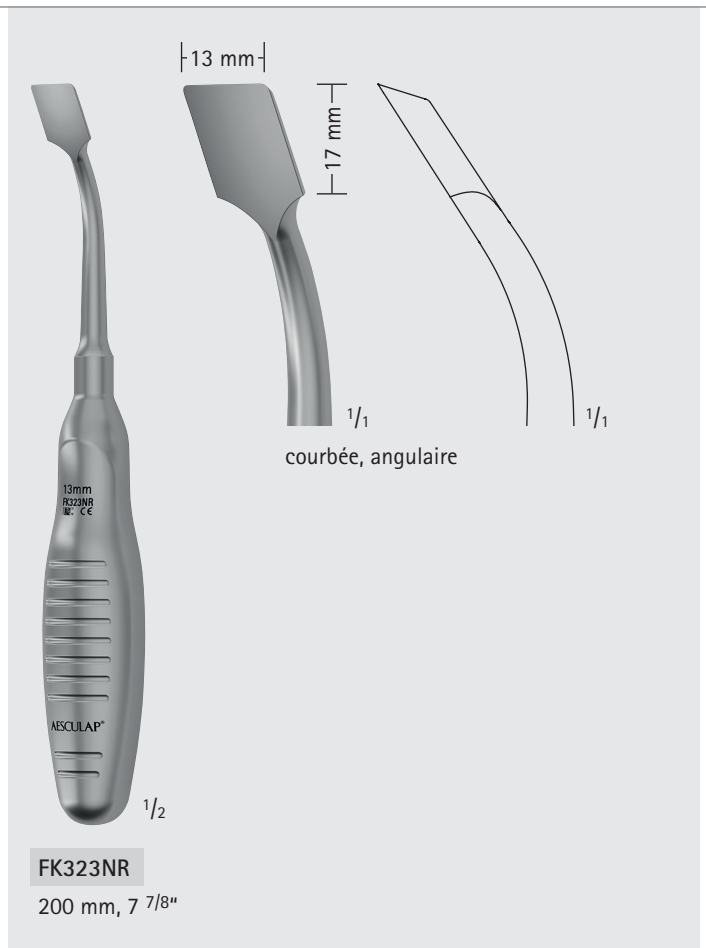
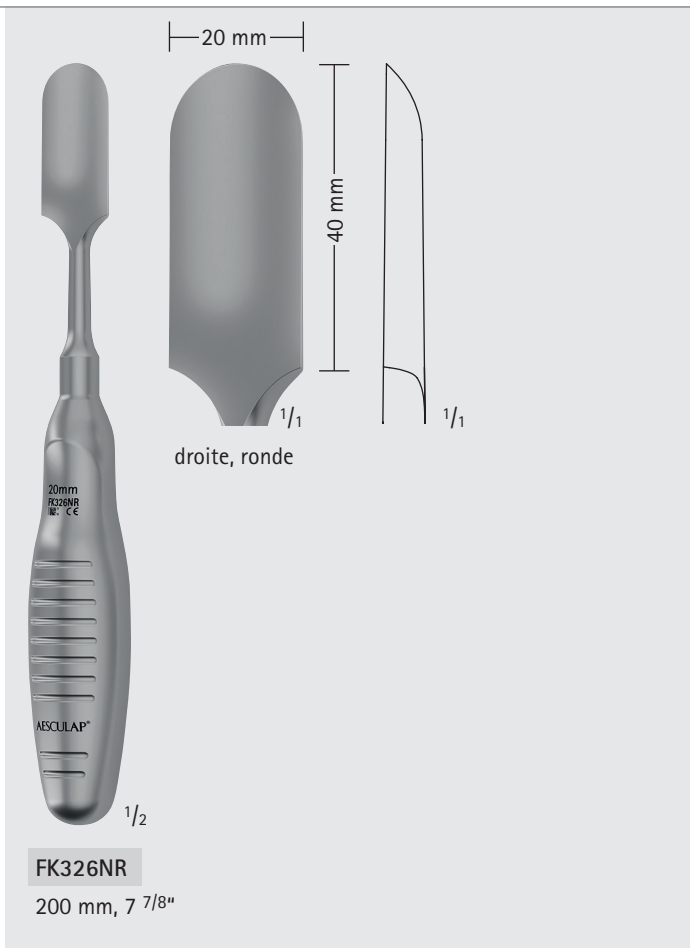

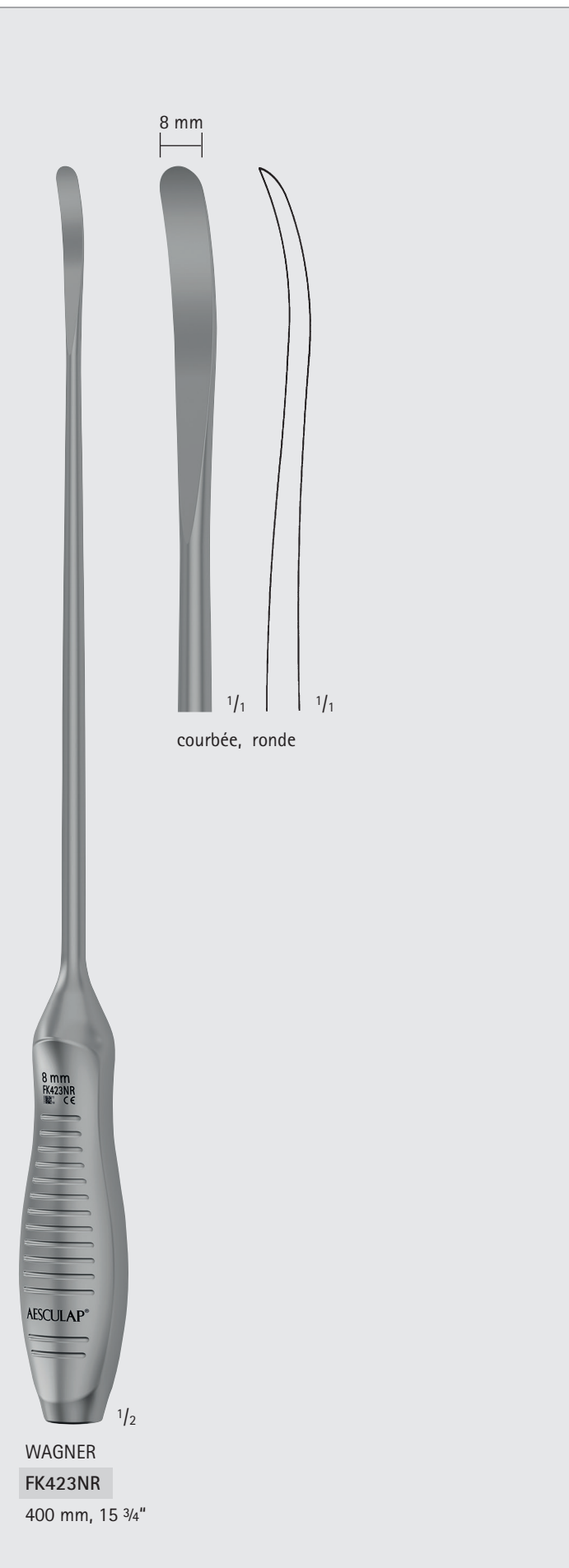
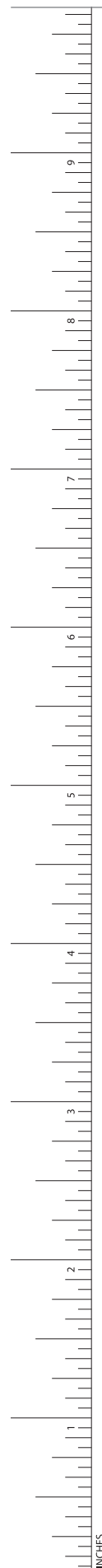

8 mm
courbée, ronde
1/1 1/1

WAGNER
FK423NR
400 mm, 15 3/4"

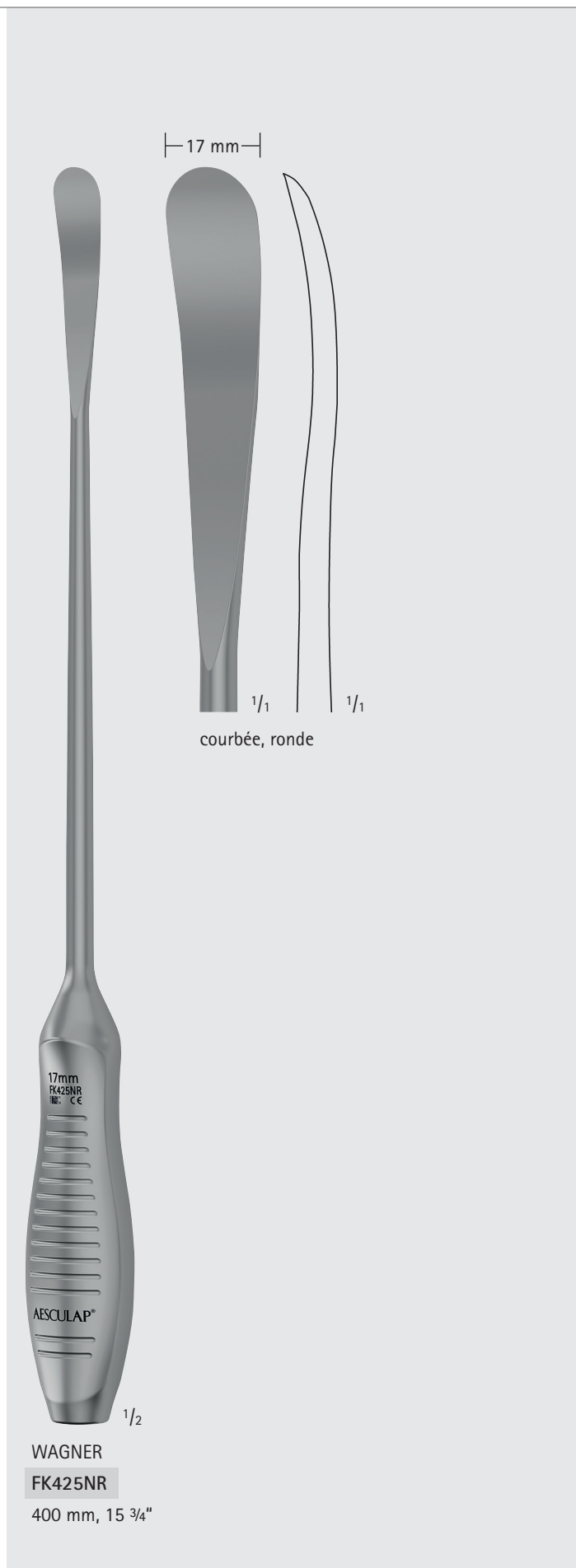

17 mm
courbée, ronde
1/1 1/1

WAGNER
FK425NR
400 mm, 15 3/4"

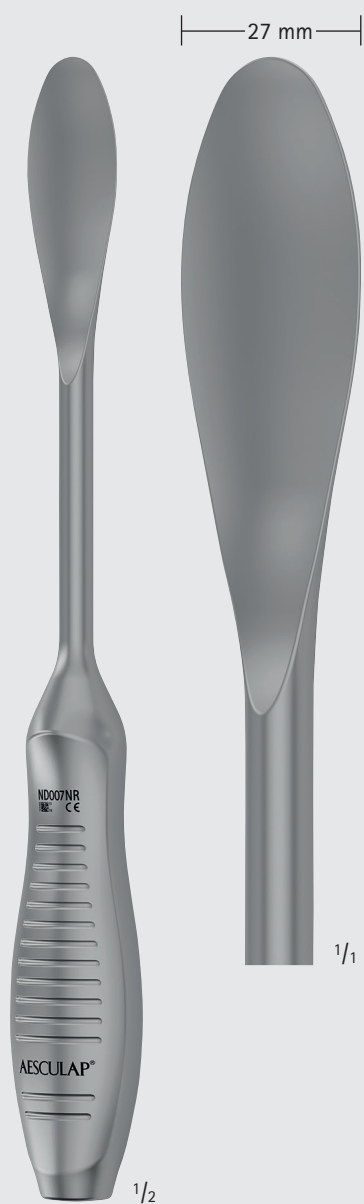

ND007NR

pour soulever la tête fémorale
300 mm, 11 3/4"

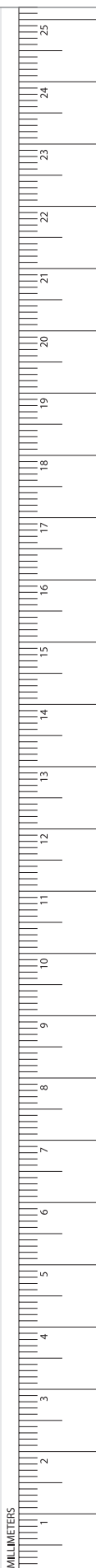

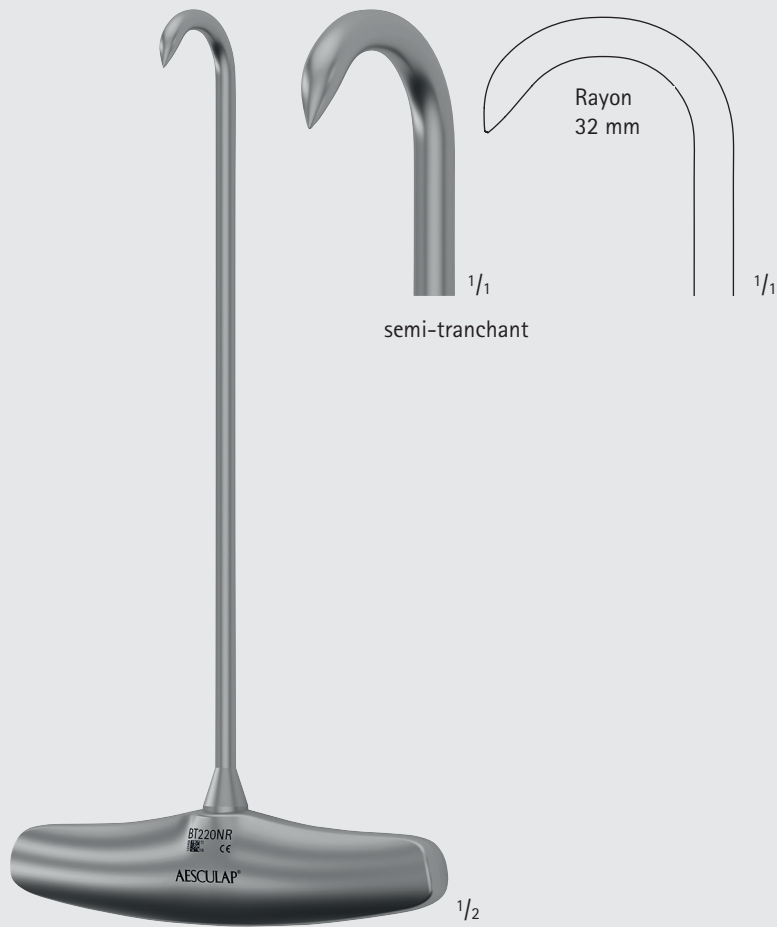

BT220NR

Crochet à os avec poignée en T
240 mm, 9 1/2"

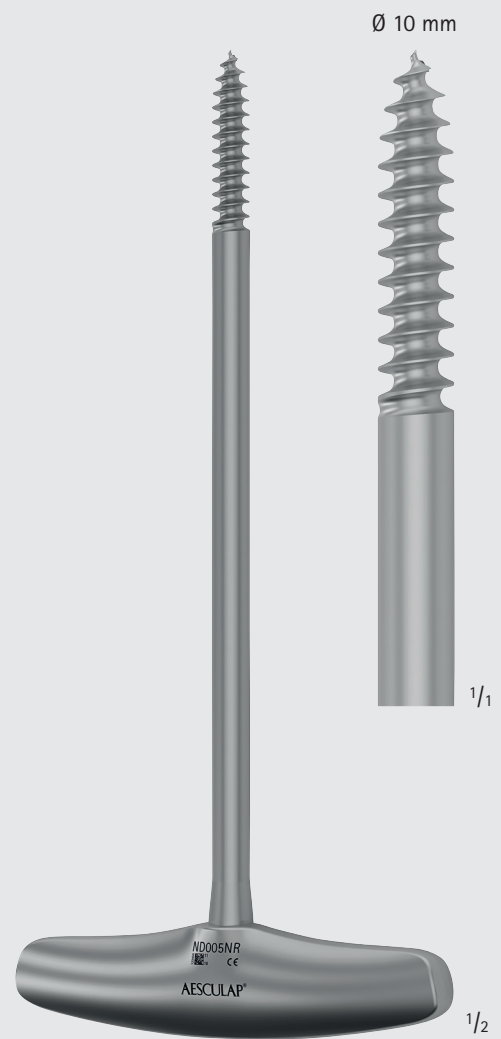

ND005NR

Perceuse à points avec poignée en T
pour l'extraction de la tête fémorale
260 mm, 10 1/4"



FO102NR
200 mm, 7 7/8"

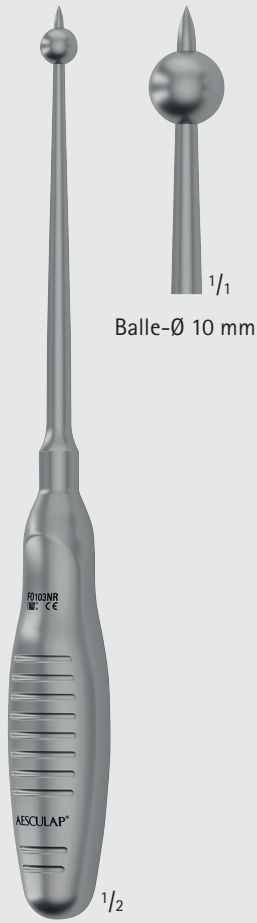

FO103NR
240 mm, 9 1/2"

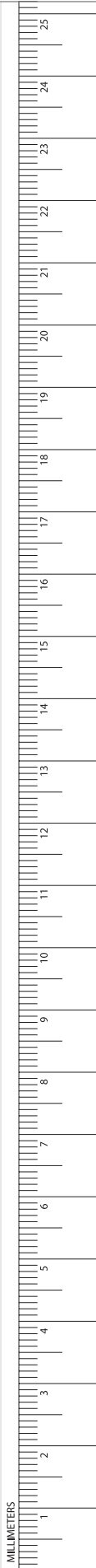

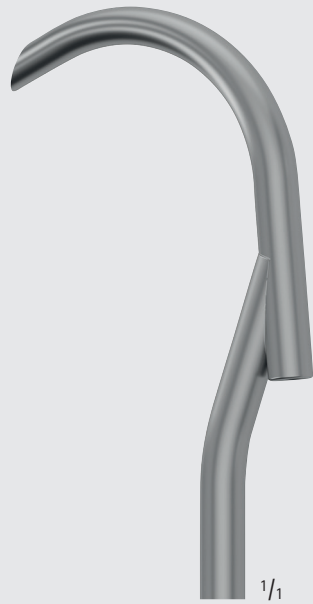
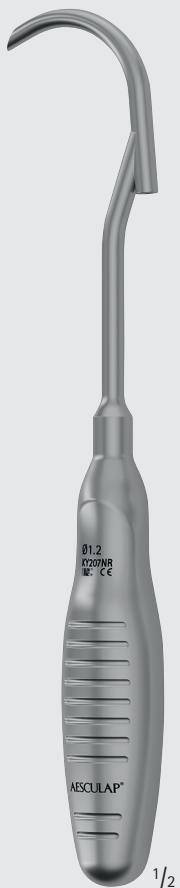
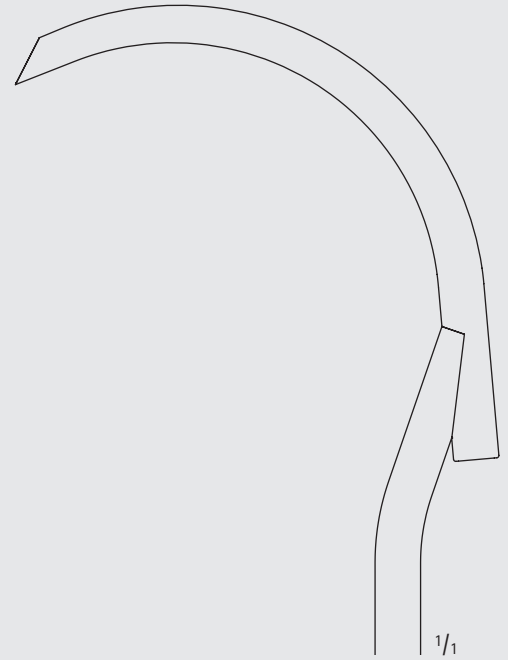
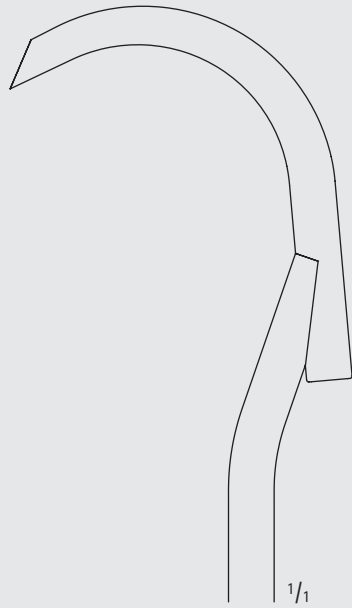
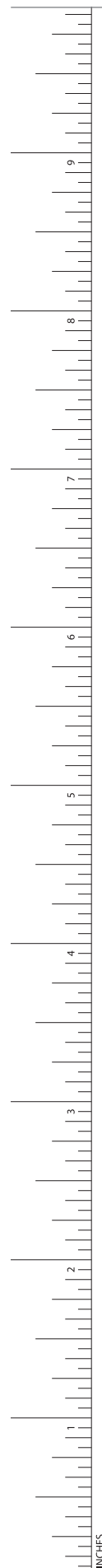

petite, courbée
pour fil-Ø 1,2 mm

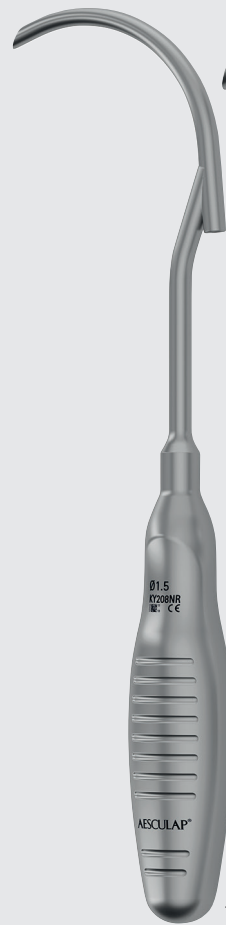

grande, courbée
pour fil -Ø 1,5 mm

KY207NR
230 mm, 9"

KY208NR
240 mm, 9 1/2"

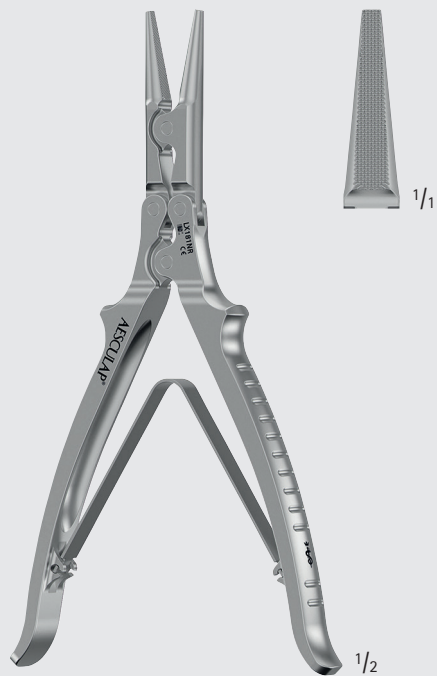

LX181NR

Pince ronde
180 mm, 7"

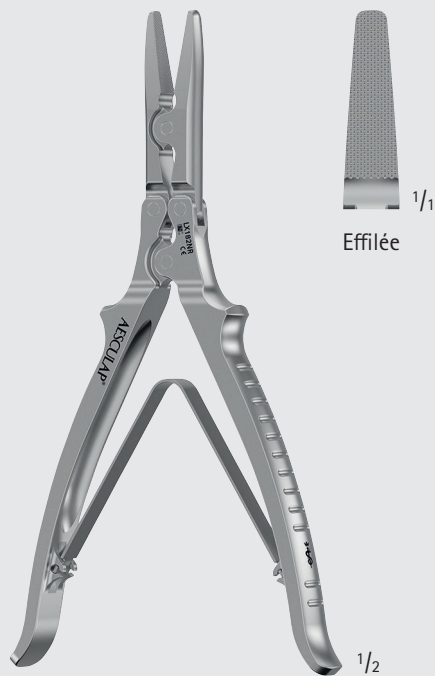

LX182NR

Pince d'extraction
180 mm, 7"

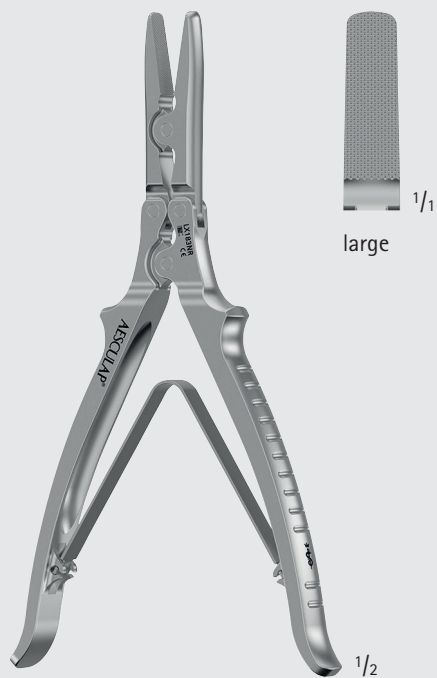

LX183NR

Pince d'extraction
180 mm, 7"

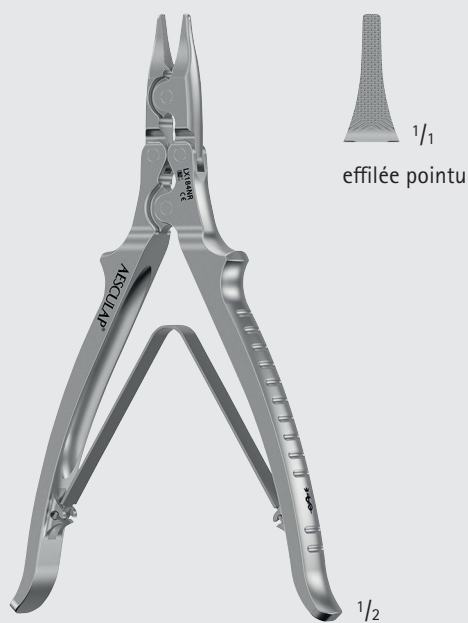

LX184NR

Pince d'extraction
160 mm, 6 1/4"

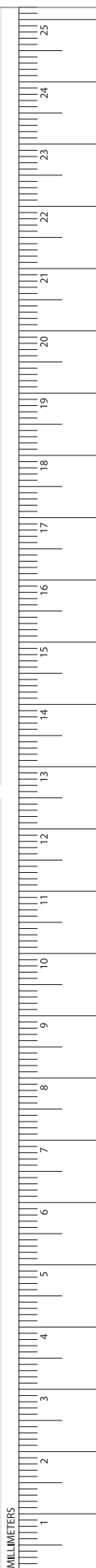

avec tranchant spécialement trempé



LX159NR

pour fils durs avec un Ø max. 1,5 mm
180 mm, 7"

avec tranchant spécialement trempé

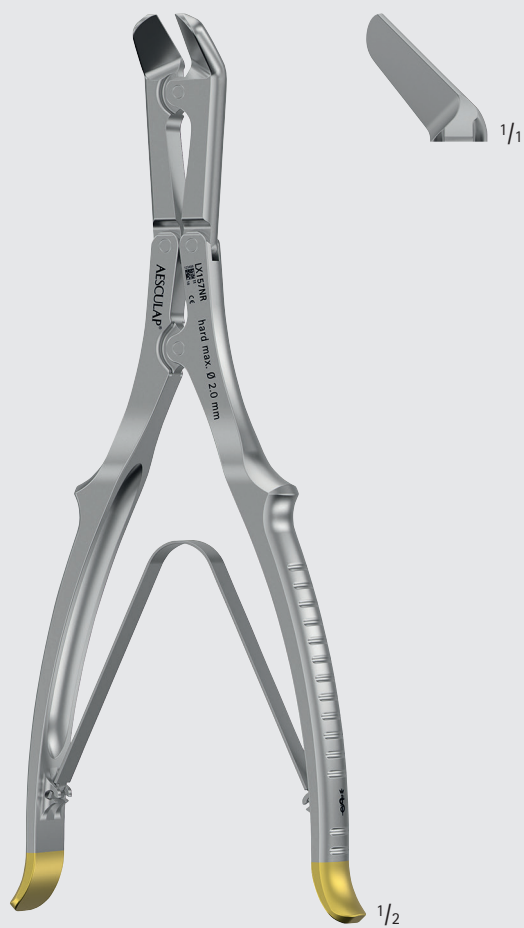

LX157NR

pour fils durs avec un Ø max. 2,0 mm
240 mm, 9 1/2"

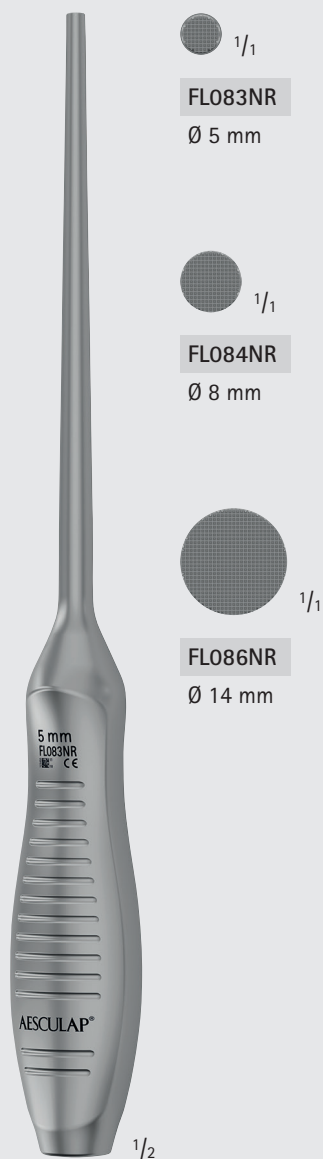

FL083NR-FL086NR

ronds
300 mm, 11 3/4"

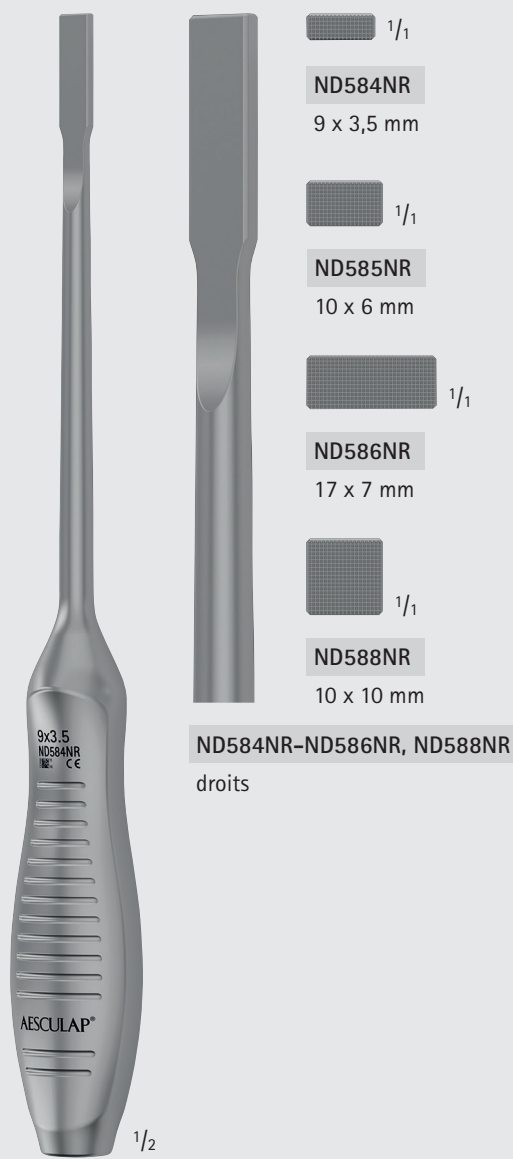

ND584NR-ND588NR

rectangulaires
300 mm, 11 3/4"



ND587NR
courbé

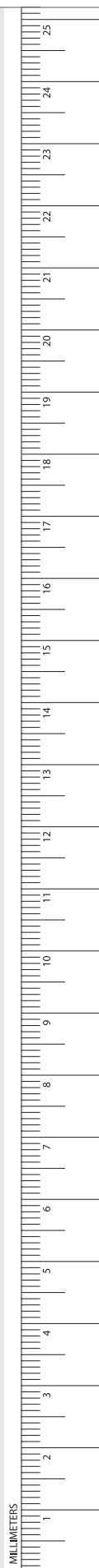

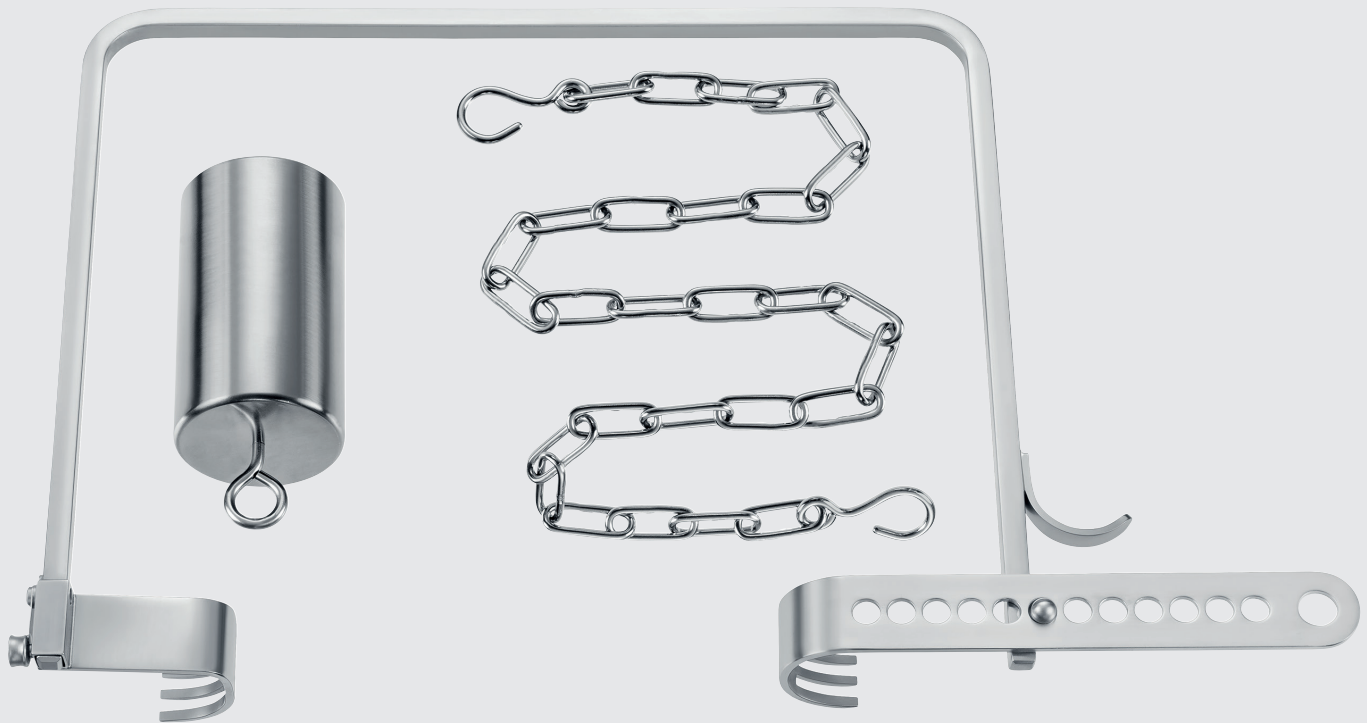

CHARNEY

MB191R

Kit de base d'écarteur, composé de:
 MG697R Cadre, 300 x 240 mm
 MG081R Poids, 1.740 g, avec chaîne
 MB156R Lame, petite, 60 mm, 37 x 25 mm
 MB157R Lame, grande, 174 mm, 42 x 25 mm



CHARNEY

Art. Nr.	Profondeur x largeur	Longueur de la lame
MG699R	25 x 25 mm	60 mm
MB156R	37 x 25 mm	60 mm
MG698R	51 x 25 mm	60 mm
MG565R	57 x 25 mm	60 mm
MG566R	64 x 25 mm	60 mm
MB177R	76 x 25 mm	60 mm
MG567R	102 x 25 mm	60 mm
MG700R	114 x 25 mm	60 mm
MB192R	127 x 25 mm	60 mm

Lames d'écarteur, petites

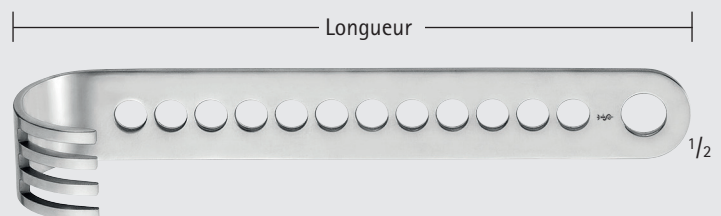

CHARNEY

Art. Nr.	Profondeur x largeur	Longueur de la lame
MG701R	25 x 25 mm	174 mm
MB157R	42 x 25 mm	174 mm
MG702R	51 x 25 mm	198 mm
MG568R	57 x 25 mm	192 mm
MG569R	65 x 25 mm	183 mm
MB178R	76 x 25 mm	174 mm
MG703R	102 x 25 mm	174 mm
MG570R	114 x 25 mm	174 mm
MB193R	127 x 25 mm	174 mm

Lames d'écarteur, grandes

Art. Nr.							
BT220NR	36	FL083NR	41	FL825NR	13	MB631NR	12
FK316NR	32	FL084NR	41	FL826NR	13	MG081R	42
FK317NR	32	FL086NR	41	FL827NR	13	MG565R	42
FK318NR	32	FL400NR	13	FL828NR	13	MG566R	42
FK319NR	32	FL401NR	13	FL830NR	15	MG567R	42
FK321NR	32	FL402NR	13	FL831NR	15	MG568R	42
FK323NR	33	FL403NR	13	FL832NR	15	MG569R	42
FK324NR	33	FL405NR	13	FL833NR	15	MG570R	42
FK325NR	33	FL406NR	13	FL835NR	15	MG697R	42
FK326NR	33	FL407NR	13	FL836NR	15	MG698R	42
FK423NR	34	FL408NR	13	FL837NR	15	MG699R	42
FK425NR	34	FL410NR	15	FL838NR	15	MG700R	42
FK630NR	29	FL411NR	15	FL920NR	13	MG701R	42
FK631NR	29	FL412NR	15	FL922NR	13	MG702R	42
FK632NR	29	FL413NR	15	FL925NR	13	MG703R	42
FK633NR	29	FL415NR	15	FL927NR	13		
FK634NR	29	FL416NR	15	FL930NR	16	ND005NR	36
FK635NR	29	FL417NR	15	FL932NR	16	ND007NR	35
FK636NR	29	FL418NR	15	FL935NR	16	ND019NR	31
FK637NR	29	FL441NR	16	FL937NR	16	ND066NR	20
FK638NR	29	FL443NR	16			ND067NR	20
FK639NR	29	FL445NR	16	F0102NR	37	ND068NR	21
FK640NR	29	FL650R	23	F0103NR	37	ND078R	21
FK641NR	29	FL651R	23	F0515NR	24	ND079R	22
FK642NR	29	FL652R	23	F0516NR	25	ND080R	22
FK643NR	29	FL653R	23	F0517NR	25	ND081R	22
FK644NR	29	FL654R	23	F0518NR	24	ND082R	22
FK645NR	29	FL655R	23	F0520NR	24	ND083R	22
FK646NR	29	FL656R	23	F0521NR	25	ND084R	22
FK647NR	29	FL658R	23	F0530NR	26	ND089R	22
FK648NR	29	FL659R	23	F0532NR	26	ND091NR	19
FK649NR	29	FL660R	23	F0534NR	26	ND092NR	19
FK696NR	31	FL662R	23	F0550NR	27	ND093NR	19
FK698NR	31	FL663R	23	F0551NR	27	ND096NR	19
FK743NR	30	FL781R	23	F0641NR	28	ND097NR	19
FK745NR	30	FL782R	23	F0645NR	28	ND098NR	19
FK747NR	30	FL783R	23			ND104NR	17
FK753NR	30	FL785R	23	KH113NR	12	ND105NR	17
FK755NR	30	FL788R	23			ND108NR	14
FK757NR	30	FL789R	23	KY207NR	38	ND109NR	14
		FL790R	23	KY208NR	38	ND118NR	18
		FL793R	23			ND376NR	18
FL046NR	10	FL800R	23	LX157NR	40	ND584NR	41
FL046211	10	FL801R	23	LX159NR	40	ND585NR	41
FL046212	10	FL802R	23	LX181NR	39	ND586NR	41
FL046213	10	FL804R	23	LX182NR	39	ND587NR	41
FL046214	10	FL806R	23	LX183NR	39	ND588NR	41
FL057NR	10	FL808R	23	LX184NR	39		
FL062NR	11	FL809R	23			MB156R	42
FL062206	11	FL810R	23			MB157R	42
FL062211	11	FL812R	23			MB177R	42
FL062212	11	FL813R	23			MB178R	42
FL062213	11	FL820NR	13			MB191R	42
FL062214	11	FL821NR	13			MB192R	42
FL066NR	10	FL822NR	13			MB193R	42
FL069NR	11	FL823NR	13				

Instruments SQ.line®

Dispositifs médicaux, consultez les notices et les étiquetages spécifiques à chacun des dispositifs pour plus d'information.

Lire attentivement les instructions figurant dans les notices et/ou sur les étiquettes.

Produits non pris en charge au titre de la LPPR* * Liste des produits et prestations remboursables au titre de l'article L-165-1 du code de la sécurité sociale

Fabriqué par

Aesculap AG | Am Aesculap-Platz | 78532 Tuttlingen | Deutschland

Tel. 07461 95-0 | Fax 07461 95-2600 | www.aesculap.de

B. Braun Medical | 26 rue Armengaud | 92210 Saint-Cloud | France

Tél. 01 41 10 53 00 | Fax 01 41 10 53 99 | www.bbraun.fr

Société par actions simplifiée au capital de 31 000 000 € | RCS Nanterre 562050856

Le présent document, son contenu, et notamment les données institutionnelles, les informations, les marques et les logos qui y sont mentionnés sont la propriété exclusive de B. Braun. Toute représentation et/ou reproduction, partielle ou totale, de ce document et de son contenu, sans l'accord exprès et préalable de B. Braun, est strictement interdite et constitue une infraction aux droits de propriété intellectuelle de B. Braun. Document réservé aux professionnels de santé. Document et photo non contractuels. Document réservé aux professionnels de santé.

Edition 07/2020

INS_20200731