



WE UNDERSTAND.

NEUROSURGERY

M.blue[®]

THE BALANCED WAY OF LIFE. INSPIRED BY YOU.

TREATMENT OF HYDROCEPHALUS

NEED FOR ACTION

WHY DOES IT NEED BETTER SOLUTIONS FOR THE TREATMENT OF HYDROCEPHALUS?

Since the 1960s, the main surgical strategy in managing hydrocephalus is the placement of shunts. However, conventional shunts have very high failure rates, and nearly every fourth patient is affected by complications (1, 2) with no difference between different conventional valves and programmable valves (4, 5).

Overdrainage-related complications can necessitate a variety of different revisions, which are burdensome for patients and are accompanied by unavoidable perioperative risks.

We believe that the current treatment situation for hydrocephalus is not acceptable and better solutions have to be found.

HIGH FAILURE RATES

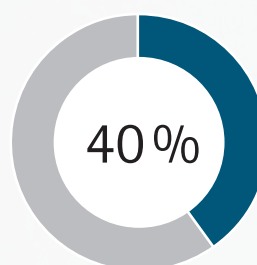

Proportion of shunts failing within **2 years**

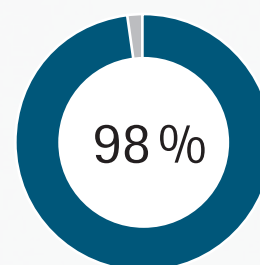

Proportion of shunts failing within **10 years**

» High failure rates overshadow the effectiveness of shunts (1).

COMPLICATIONS (3)

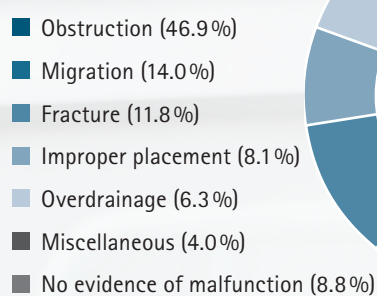

» About one in four patients experiences at least one complication (2).



TREATMENT OF HYDROCEPHALUS

NEED FOR ACTION



MECHANICAL FAILURE

Mechanical failure is the most common cause of multiple shunt revisions (6), with catheter or valve obstruction being the predominant reason (3). However, failure of individual shunt components may also occur, e.g., at stress points or due to poor design (7).



Catheter breakage



Catheter fracture



Obstruction



Catheter separation



Damaged housing

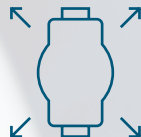

Valve migration



ACCIDENTAL REPROGRAMMING

As the optimal pressure setting of adjustable valves is of great importance for the patient, the accidental reprogramming of adjustable valves by external magnetic fields, e.g., from smartphones, is a cause of concern and leads to great uncertainty among patients and doctors (8-12).

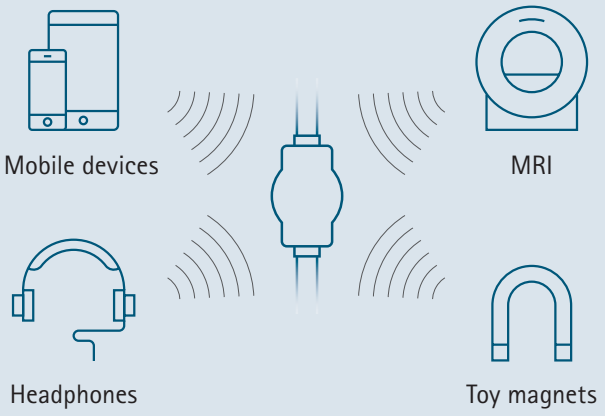

TREATMENT OF HYDROCEPHALUS

NEED FOR ACTION

WHAT COULD BE BETTER?

Active patients are exposed to gravity – for up to 16 hours, every day. Posture-dependent gravitational effects increase the potential for overdrainage. Overcoming these gravitational effects can help to improve patient outcomes.





NO TWO PATIENTS ARE ALIKE!

Every patient with hydrocephalus is unique and requires customized setting of the valve opening pressure.

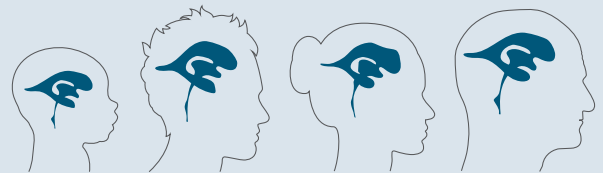

ARE PATIENTS GETTING OPTIMAL INDIVIDUAL TREATMENT?

Determining the patient-individual setting of the valve opening pressure can be complex. Non-ideal pressure settings can lead to follow-up examinations and revisions, which are burdensome for patients and put an additional strain on physicians and surgeons with limited time and high workload (13, 14).

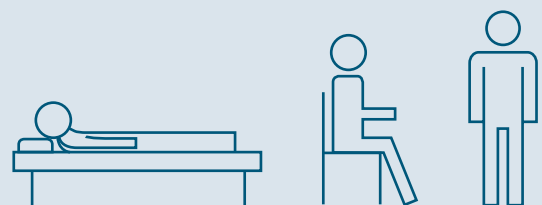

ARE ADJUSTABLE DIFFERENTIAL PRESSURE VALVES THE BEST AVAILABLE THERAPIE?

The pressure setting of conventional adjustable valves is always a compromise between the pressure requirements of the upright position and the supine position. Therefore, patients can never benefit from optimal opening pressures for both positions.

GRAVITATIONAL VALVES BY MIETHKE

DEVELOPED TO ENSURE SAFETY



BE CONFIDENT!

Gravitational shunts provide neurosurgeons with a possibility to address the posture-dependent effects of gravity, with positive clinical outcomes for the patient and a significant reduction of overdrainage events (15).

GRAVITATIONAL VALVES (GV) IMPROVE PATIENT OUTCOMES COMPARED TO DIFFERENTIAL PRESSURE VALVES (DP) (16).

Symptom improvement >2 points on Kiefer-Scale.

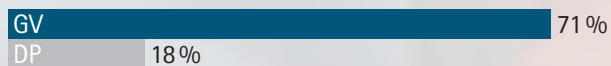

Daily improvement rated good/very good on Black-Scale.





REDUCE COMPLICATIONS! REDUCE REVISIONS!

Clinical studies have shown that MIETHKE gravitational devices reduce the risk of revisions (17-21) and overdrainage complications (18).

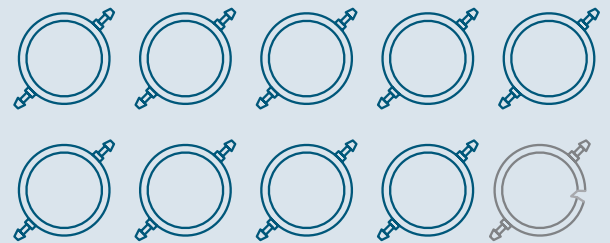

» Valve survival rates up to 90% at 12 months (19).

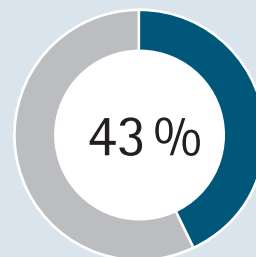

Overdrainage rate with **differential pressure** valves

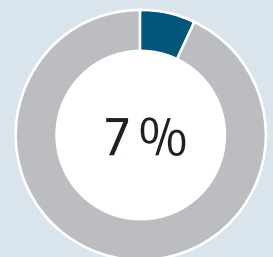

Overdrainage rate with **gravitational** valves

» Implanting a gravitational valve avoids one additional overdrainage complication in about every third patient (18).

GRAVITATIONAL VALVES BY MIETHKE

DEVELOPED TO ENSURE SAFETY

AVOID MECHANICAL FAILURE!

All MIETHKE valves are manufactured with high precision from titanium. The extremely small valves have aligned flow paths, rigid housing unsusceptible to subcutaneous pressure and high MRI- and biocompatibility.

DON'T LET MAGNETIC FIELDS BOTHER YOU!

The "Active-Lock mechanism" protects programmable MIETHKE valves against reprogramming by magnetic fields of up to 3 Tesla (22).

MIETHKE GRAVITATIONAL VALVES



Made from Titanium
for high MRI- and
biocompatibility



Protected against
reprogramming
up to 3 Tesla



Extremely small valve



Rigid housing
unsusceptible to
subcutaneous pressure





BENEFIT FROM PRIMARY IMPLANTATION (23)!



22 %

higher survival of gravitational valves after **primary** vs secondary implantation

GET IT RIGHT THE FIRST TIME!

Early treatment with the optimal therapy is important for patients with hydrocephalus (23, 24) and can also help to avoid shunt replacements and associated perioperative risks.

OPTIMIZE – DON'T COMPROMISE!

Gravitational shunts allow for the prevention of over-drainage in the standing position without compromising the pressure setting for the supine position. The optimal opening pressure for each patient can be set both for the upright and the supine position – without needing to compromise.

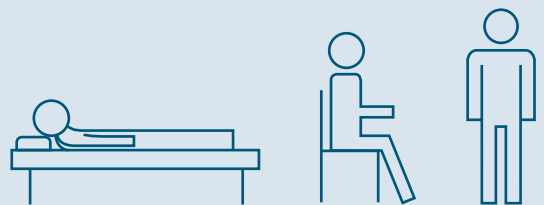

» With gravitational valves the optimal pressure for both supine and upright position can be set.

M.blue®

OUR LATEST GENERATION OF VALVE TECHNOLOGY

- ONE valve for the special requirements of a life with hydrocephalus: mobility, growth, changes in the course of disease
- 2 in 1 technology: adjustable gravitational unit combined with fixed differential pressure unit in one valve
- Unique uncompromising pressure adaption to fulfill individual patient needs
- Smallest adjustable gravitational valve worldwide
- Efficient protection against overdrainage through individually and continuously adjustable opening pressure from 0-40 cmH₂O
- MRI-compatible up to 3 Tesla – no X-ray verification after MRI necessary, no additional radiation exposure for the patient
- Safe from unintentional adjustment by everyday magnets such as smartphones, toys, induction cookers and safety barriers at the airports
- Innovative *M.blue plus*® Instruments for *M.blue*® and *proGAV*® 2.0
- Intuitive, secure and comfortable adjustment
- Precision engineering
- Robust and durable: made of titanium

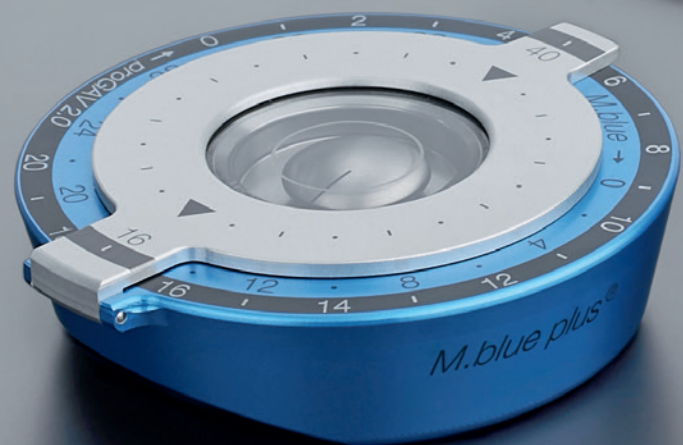



M.blue® & M.blue plus®

M.blue® is the essence of 26 years of experience with hydrocephalus and valve technology and the feedback of numerous physicians and patients worldwide.

M.blue® is a valve for all forms of hydrocephalus with a particularly high flexibility in therapy.

M.blue[®]

FUNCTIONALITY OF VALVE AND POSITION OF THE BODY

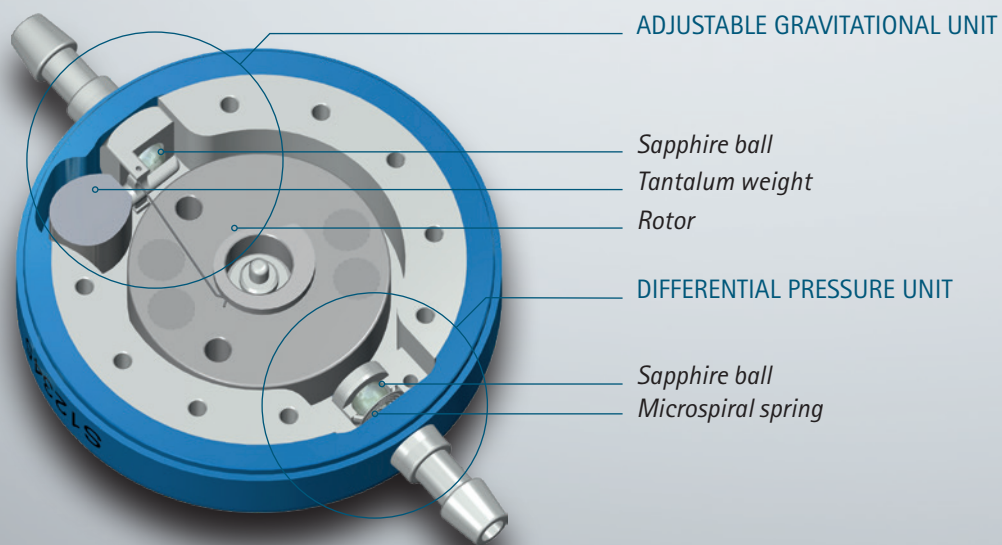

The functionality of *M.blue*[®] is illustrated interactively in the MIETHKE app.

APP DOWNLOAD

<https://apps.apple.com/de/app/miethke/id450290015>

<https://play.google.com/store/apps/details?id=com.miethke.graviton>



EXAMPLE OF THE ADJUSTABLE GRADUATED PRESSURE RANGE OF A *M.blue*[®] WITH A DIFFERENTIAL PRESSURE UNIT OF 5 CMH₂O

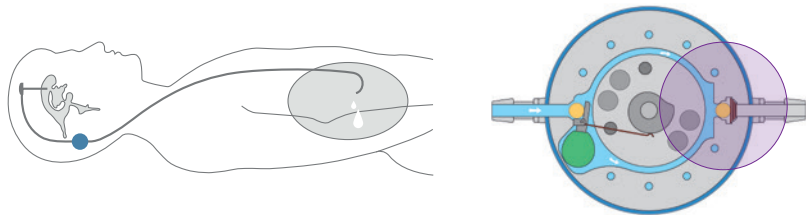
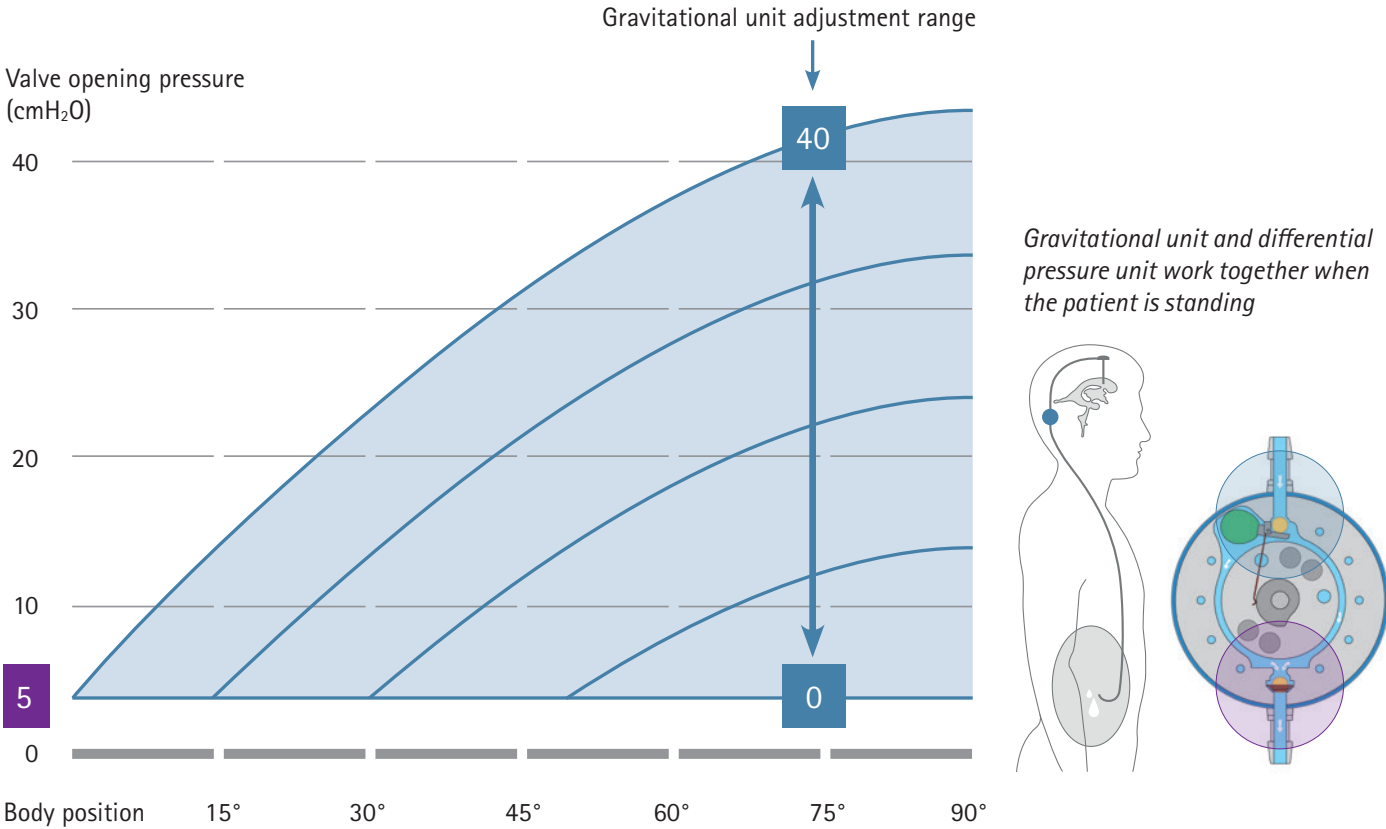

Only the differential pressure unit is active when the patient is supine

M.blue[®] is a hydrocephalus valve operating in a position-dependent manner. It consists of an adjustable gravitational unit and a fixed differential pressure unit. The combination of these two units adjusts the opening pressure

automatically depending on what position the patient is in, thus countering the risk of possible overdrainage complications, particularly when the patient is in an upright and active position.

M.blue plus® INSTRUMENTS

SOFT TOUCH INSTRUMENT FUNCTIONALITY

USER-FRIENDLY ADJUSTMENT AND VERIFICATION

M.blue plus® instruments allow users to measure, verify, and adjust the pressure level on M.blue®'s adjustable gravitational unit (0-40 cmH₂O) as well as the pressure level on the adjustable differential pressure unit (proGAV® 2.0) of M.blue plus®. The instruments offer simple steps for the physician and make the adjustment process comfortable for patients.

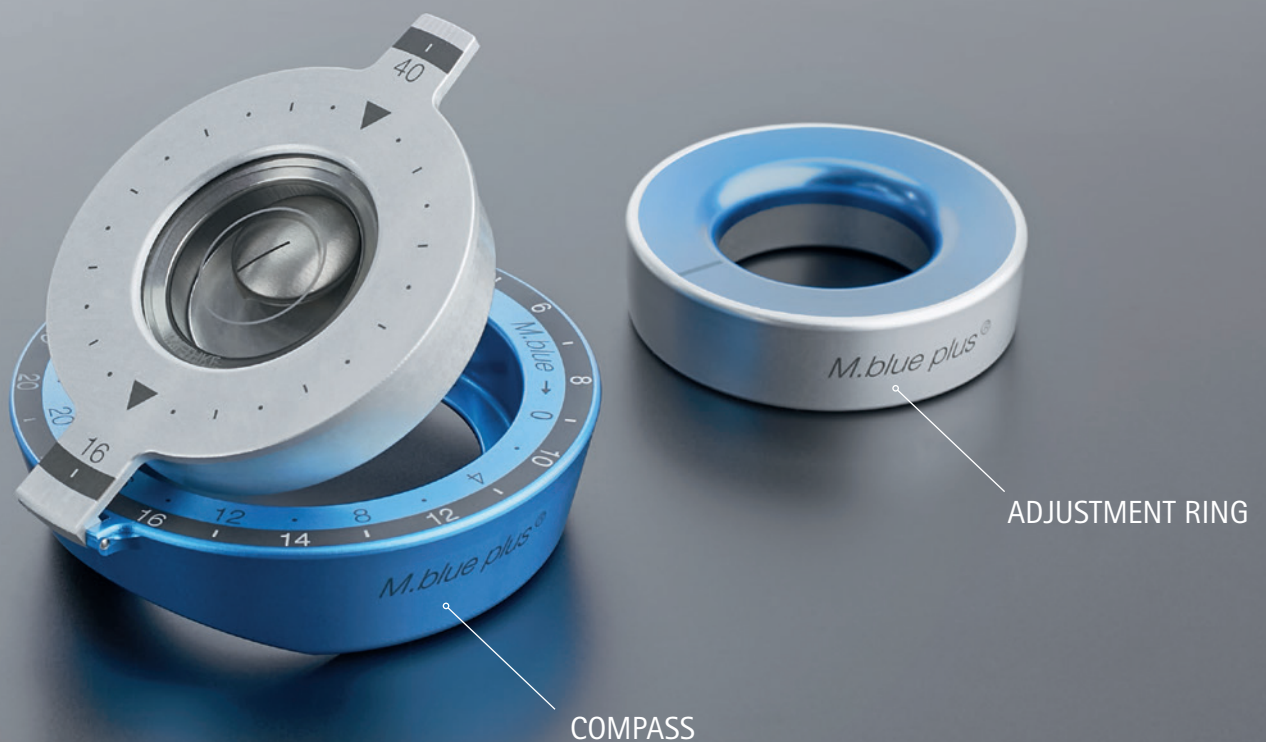



LOCATE

Locate valve by palpating the area with your finger through the open *M.blue plus*® compass.

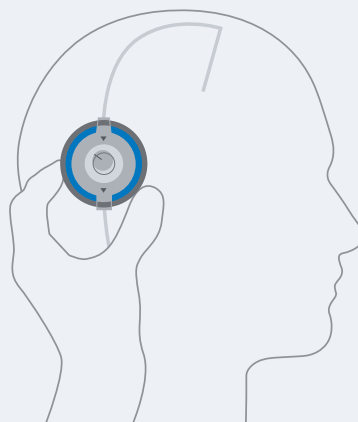





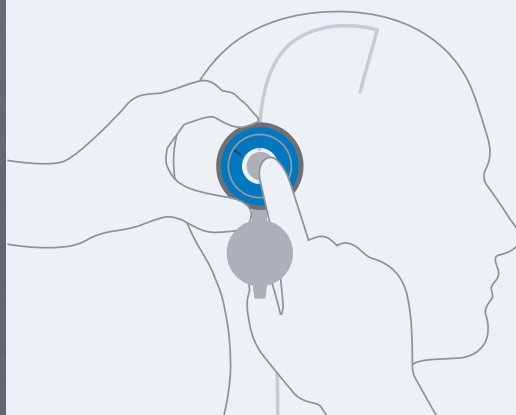

VERIFY

Close *M.blue plus*® compass and use the floater to lock location and read current valve opening pressure setting.

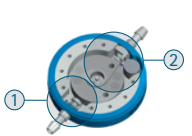

ADJUST

With the help of the inserted adjustment ring the valve opening pressure can easily be set to the desired level. After setting the valve opening pressure, it is advisable to double-check the pressure level settings.

Patient	Selection of pressure levels		Combined opening pressure		
					
	① Differential pressure unit	② Adjustable gravitational unit			
Newborns and children under 5 	5	20	5	25	
Children ages 5 and up 				25	30
Adults < 1.60 m  > 1.80 m				25	30
				20	25
Adults > 65 years  < 1.60 m > 1.80 m				30	35
		20		25	
		15		20	
		25		30	

All of the pressure levels shown here are given in cmH₂O. These recommendations are non-binding. The treating physician will need to decide each case individually.

PRESSURE LEVEL RECOMMENDATION

The choice of the appropriate pressure level of *M.blue*® depends on several other factors, including age, degree of activity, size and stature of the patient. The values given apply to mobile patients. For patients with little mobility or a high BMI, the pressure of the gravitational unit should be chosen lower than recommended above.

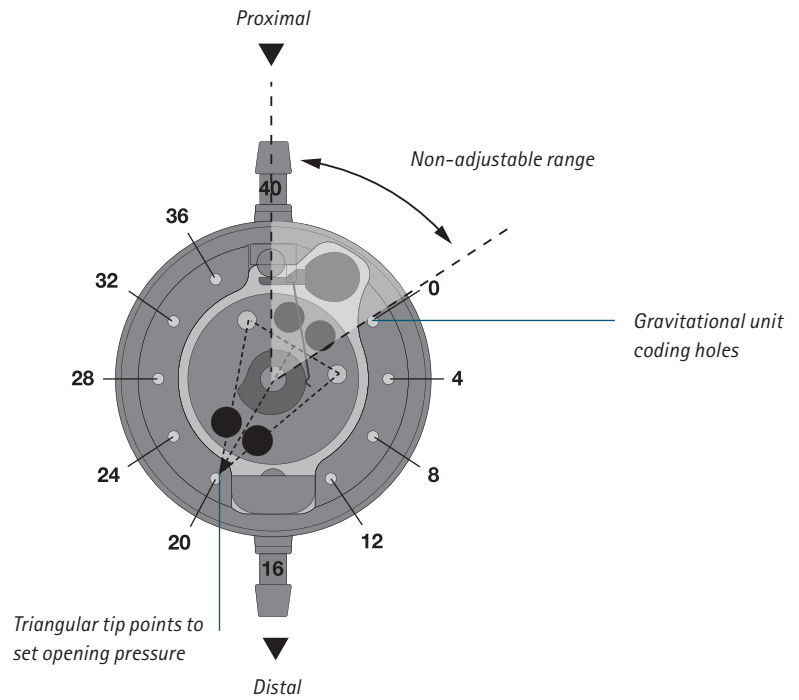
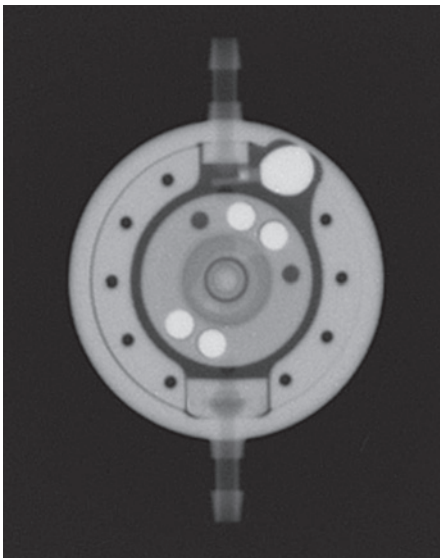

USING RADIOGRAPHIC IMAGING TO DETERMINE PRESSURE LEVELS

Pressure settings on *M.blue*[®] should always be checked using *M.blue plus*[®] compass, but radiographic imaging can be used for verification as well.

All of the pressure levels shown here are given in cmH₂O.

X-ray recognition and product information can be found in the free MIETHKE App.

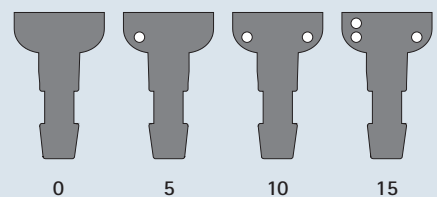
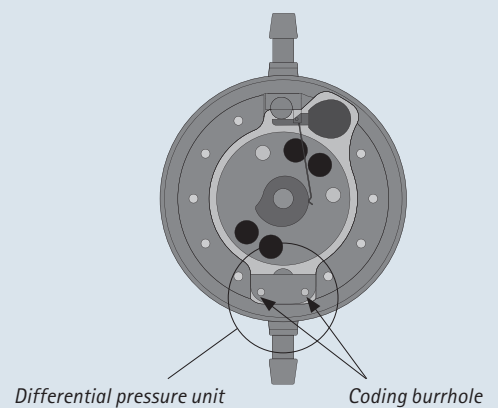

M.blue[®]

SINGLE VALVE

▪ M.blue[®] valve



Diameter connector: 1.9 mm
Recommended catheter diameters:
Inner diameter: 1.2 mm
Outer diameter: 2.5 mm

M.blue[®]

Art. no.	Differential pressure unit	Adjustable gravitational unit
FX800T	0 cmH ₂ O	0 - 40 cmH ₂ O
FX801T	5 cmH ₂ O	0 - 40 cmH ₂ O
FX802T	10 cmH ₂ O	0 - 40 cmH ₂ O
FX803T	15 cmH ₂ O	0 - 40 cmH ₂ O

M.blue plus®

VALVE COMBINATION



- M.blue plus® valve

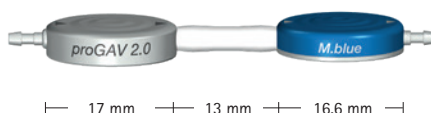

Diameter connector: 1.9 mm
Recommended catheter diameters:
Internal diameter: 1.2 mm
Outer diameter: 2.5 mm

M.blue plus®

Art. no.	Adj. differential pressure unit	Adjustable gravitational unit
FX804T	0 - 20 cmH ₂ O	0 - 40 cmH ₂ O

M.blue[®]

INDIVIDUAL VALVE WITH CATHETER

- M.blue[®] valve with distal catheter

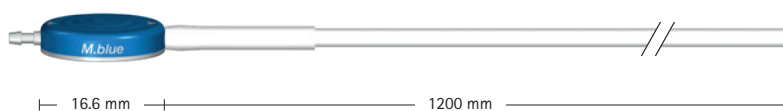

M.blue[®]

Art. no.	Differential pressure unit	Adjustable gravitational unit
FX805T	0 cmH ₂ O	0 - 40 cmH ₂ O
FX806T	5 cmH ₂ O	0 - 40 cmH ₂ O
FX807T	10 cmH ₂ O	0 - 40 cmH ₂ O
FX808T	15 cmH ₂ O	0 - 40 cmH ₂ O

M.blue plus®

VALVE COMBINATION



- M.blue plus® valve with distal catheter

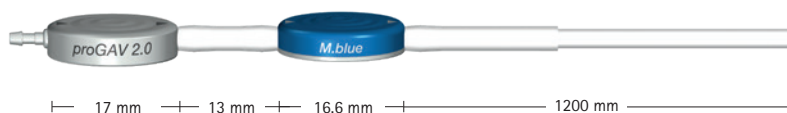

M.blue plus®

Art. no.	Adj. differential pressure unit	Adjustable gravitational unit
FX809T	0 - 20 cmH ₂ O	0 - 40 cmH ₂ O

M.blue[®]

SHUNT SYSTEM

- M.blue[®] valve with distal catheter

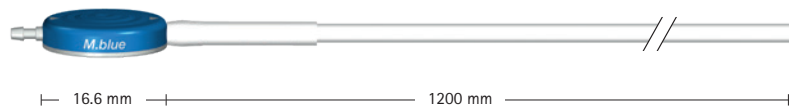

- Ventricular catheter with introducing stylet and pediatric burrhole deflector (14 mm)

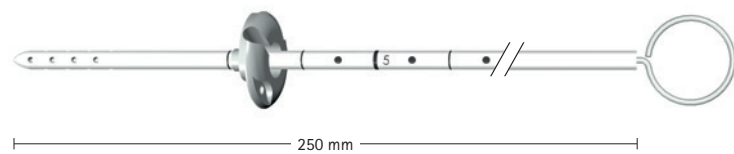

M.blue[®]

Art. no.	Differential pressure unit	Adjustable gravitational unit
FX810T	0 cmH ₂ O	0 - 40 cmH ₂ O
FX811T	5 cmH ₂ O	0 - 40 cmH ₂ O
FX812T	10 cmH ₂ O	0 - 40 cmH ₂ O
FX813T	15 cmH ₂ O	0 - 40 cmH ₂ O

M.blue plus®

SHUNT SYSTEM



- M.blue plus® valve with distal catheter

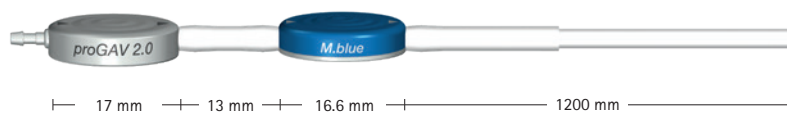

- Ventricular catheter with introducing stylet and pediatric burrhole deflector (14 mm)

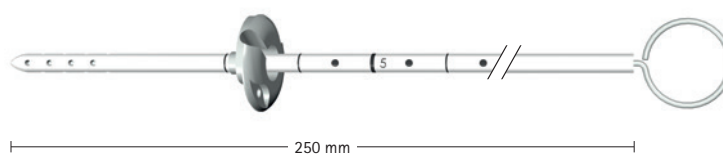

M.blue plus®

Art. no.	Adj. differential pressure unit	Adjustable gravitational unit
FX814T	0 - 20 cmH ₂ O	0 - 40 cmH ₂ O

M.blue®

SHUNT SYSTEM WITH PEDIATRIC CONTROL RESERVOIR

- M.blue® valve with integrated pediatric CONTROL RESERVOIR and distal catheter

* An additional valve in the inlet of the pediatric CONTROL RESERVOIR makes it possible to pump cerebrospinal fluid in the direction of drainage only, allowing inspection of both the distal drainage section as well as the ventricular catheter.

- Ventricular catheter with introducing stylet and pediatric burrhole deflector (14 mm)

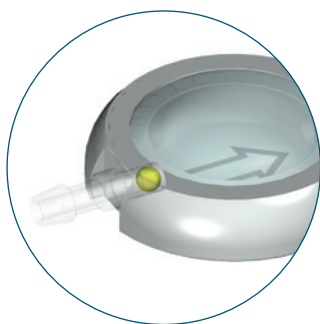
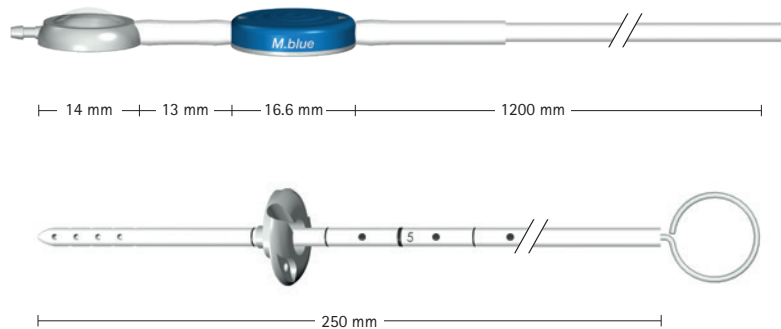

pediatric CONTROL RESERVOIR*

M.blue®

Art. no.	Differential pressure unit	Adjustable gravitational unit
FX815T	0 cmH ₂ O	0 - 40 cmH ₂ O
FX816T	5 cmH ₂ O	0 - 40 cmH ₂ O
FX817T	10 cmH ₂ O	0 - 40 cmH ₂ O
FX818T	15 cmH ₂ O	0 - 40 cmH ₂ O

M.blue plus®



SHUNT SYSTEM WITH PEDIATRIC CONTROL RESERVOIR

- M.blue plus® valve with integrated pediatric CONTROL RESERVOIR and distal catheter

* An additional valve in the inlet of the pediatric CONTROL RESERVOIR makes it possible to pump cerebrospinal fluid in the direction of drainage only, allowing inspection of both the distal drainage section as well as the ventricular catheter.

- Ventricular catheter with introducing stylet and pediatric burrhole deflector (14 mm)

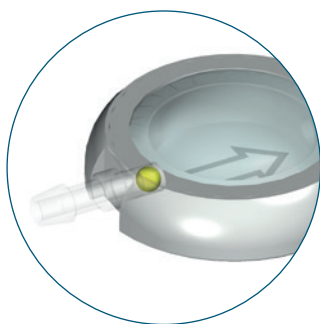
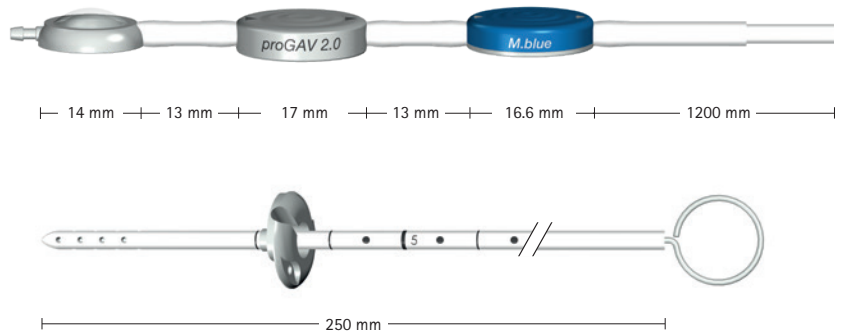

pediatric CONTROL RESERVOIR*

M.blue plus®

Art. no.	Adj. differential pressure unit	Adjustable gravitational unit
FX819T	0 - 20 cmH ₂ O	0 - 40 cmH ₂ O

M.blue®

SHUNT SYSTEM WITH CONTROL RESERVOIR

- M.blue® valve with integrated CONTROL RESERVOIR and distal catheter

* An additional valve in the inlet of the CONTROL RESERVOIR makes it possible to pump cerebrospinal fluid in the direction of drainage only, allowing inspection of both the distal drainage section as well as the ventricular catheter.

- Ventricular catheter with introducing stylet and burrhole deflector (20 mm)

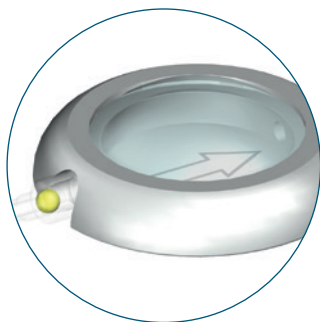
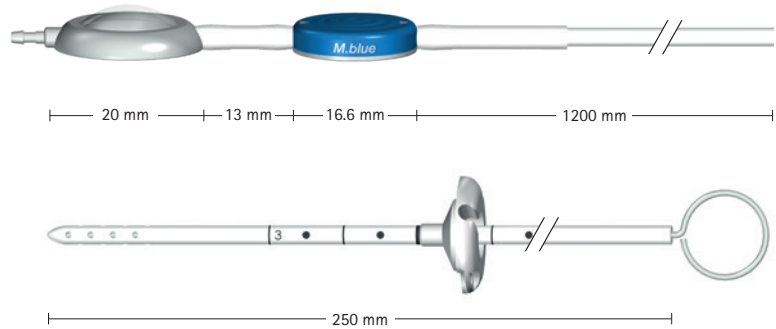

CONTROL RESERVOIR*

M.blue®

Art. no.	Differential pressure unit	Adjustable gravitational unit
FX820T	0 cmH ₂ O	0 - 40 cmH ₂ O
FX821T	5 cmH ₂ O	0 - 40 cmH ₂ O
FX822T	10 cmH ₂ O	0 - 40 cmH ₂ O
FX823T	15 cmH ₂ O	0 - 40 cmH ₂ O

M.blue plus®

SHUNT SYSTEM WITH CONTROL RESERVOIR



- M.blue plus® valve with integrated CONTROL RESERVOIR and distal catheter

* An additional valve in the inlet of the CONTROL RESERVOIR makes it possible to pump cerebrospinal fluid in the direction of drainage only, allowing inspection of both the distal drainage section as well as the ventricular catheter.

- Ventricular catheter with introducing stylet and burrhole deflector (20 mm)

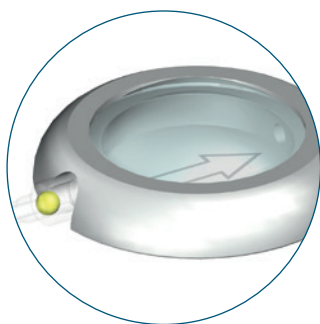
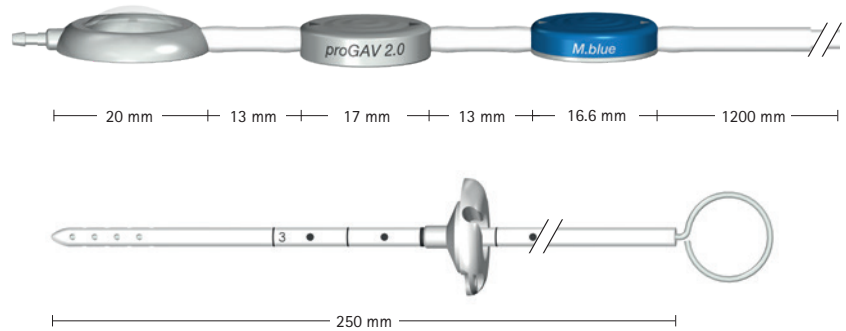

CONTROL RESERVOIR*

M.blue plus®

Art. no.	Adj. differential pressure unit	Adjustable gravitational unit
FX824T	0 - 20 cmH ₂ O	0 - 40 cmH ₂ O

M.blue®

SHUNT SYSTEM WITH PEDIATRIC SPRUNG RESERVOIR

- M.blue® valve with integrated pediatric SPRUNG RESERVOIR and distal catheter

* An additional valve in the inlet of the pediatric SPRUNG RESERVOIR makes it possible to pump cerebrospinal fluid in the direction of drainage, allowing inspection of both the distal drainage section as well as the ventricular catheter.

- Ventricular catheter with introducing stylet

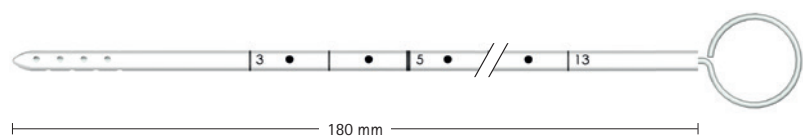
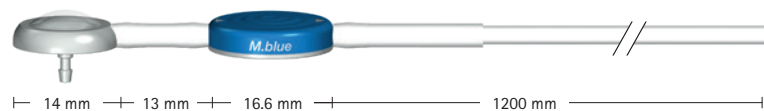

OCCIPITAL ONLY

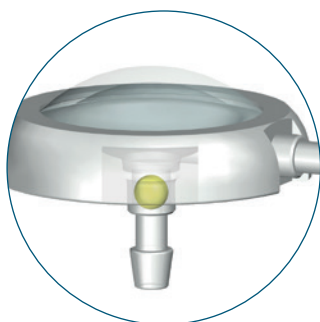

pediatric SPRUNG RESERVOIR*

M.blue®

Art. no.	Differential pressure unit	Adjustable gravitational unit
FX825T	0 cmH ₂ O	0 - 40 cmH ₂ O
FX826T	5 cmH ₂ O	0 - 40 cmH ₂ O
FX827T	10 cmH ₂ O	0 - 40 cmH ₂ O
FX828T	15 cmH ₂ O	0 - 40 cmH ₂ O

M.blue plus®



SHUNT SYSTEM WITH PEDIATRIC SPRUNG RESERVOIR

- M.blue plus® valve with integrated pediatric SPRUNG RESERVOIR and distal catheter

* An additional valve in the inlet of the pediatric SPRUNG RESERVOIR makes it possible to pump cerebrospinal fluid in the direction of drainage only, allowing inspection of both the distal drainage section as well as the ventricular catheter.

- Ventricular catheter with introducing stylet

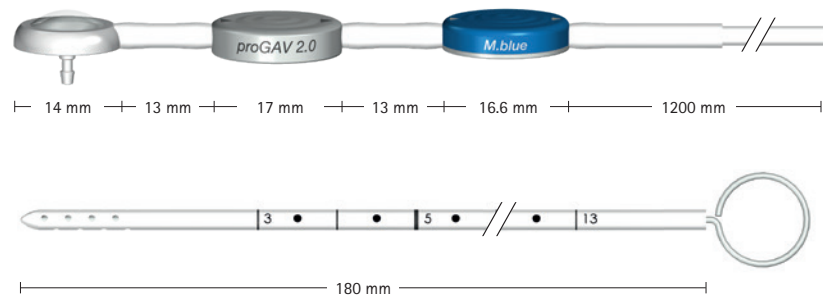

OCCIPITAL ONLY

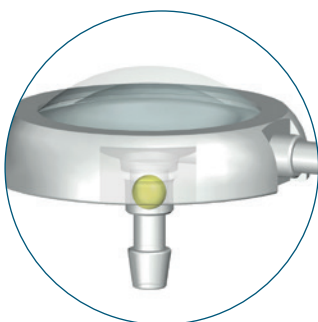

pediatric SPRUNG RESERVOIR*

M.blue plus®

Art. no.	Adj. differential pressure unit	Adjustable gravitational unit
FX829T	0 - 20 cmH ₂ O	0 - 40 cmH ₂ O

M.blue®

SHUNT SYSTEM WITH SPRUNG RESERVOIR

- M.blue® valve with integrated SPRUNG RESERVOIR and distal catheter

* An additional valve in the inlet of the SPRUNG RESERVOIR makes it possible to pump cerebrospinal fluid in the direction of drainage only, allowing inspection of both the distal drainage section as well as the ventricular catheter.

- Ventricular catheter with introducing stylet

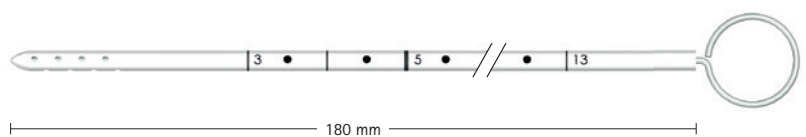
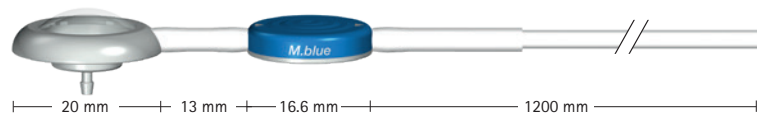

OCCIPITAL ONLY

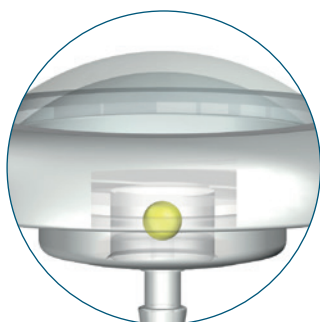

SPRUNG RESERVOIR*

M.blue®

Art. no.	Differential pressure unit	Adjustable gravitational unit
FX830T	0 cmH ₂ O	0 - 40 cmH ₂ O
FX831T	5 cmH ₂ O	0 - 40 cmH ₂ O
FX832T	10 cmH ₂ O	0 - 40 cmH ₂ O
FX833T	15 cmH ₂ O	0 - 40 cmH ₂ O

M.blue plus®

SHUNT SYSTEM WITH *SPRUNG RESERVOIR*



- M.blue plus® valve with integrated *SPRUNG RESERVOIR* and distal catheter

* An additional valve in the inlet of the *SPRUNG RESERVOIR* makes it possible to pump cerebrospinal fluid in the direction of drainage only, allowing inspection of both the distal drainage section as well as the ventricular catheter.

- Ventricular catheter with introducing stylet

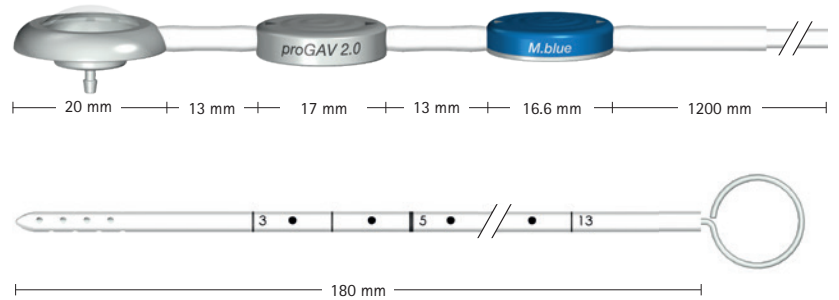

OCCIPITAL ONLY

M.blue plus®

Art. no.	Adj. differential pressure unit	Adjustable gravitational unit
FX834T	0 - 20 cmH ₂ O	0 - 40 cmH ₂ O

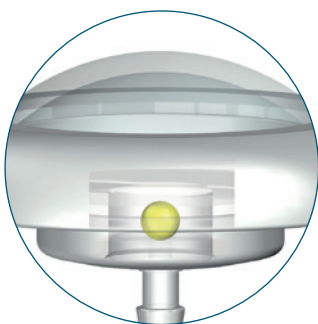

*SPRUNG RESERVOIR**

M.blue®

SHUNT SYSTEM WITH PEDIATRIC SPRUNG RESERVOIR

- M.blue® valve with distal catheter

- Pediatric SPRUNG RESERVOIR with distal catheter

* An additional valve in the inlet of the pediatric SPRUNG RESERVOIR makes it possible to pump cerebrospinal fluid in the direction of drainage only, allowing inspection of both the distal drainage section as well as the ventricular catheter.

- Ventricular catheter with introducing stylet

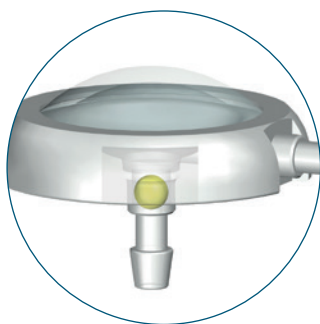
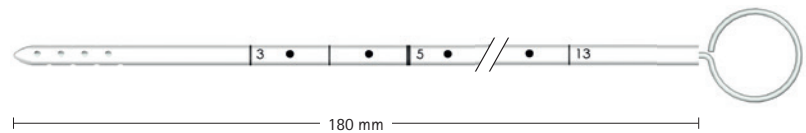
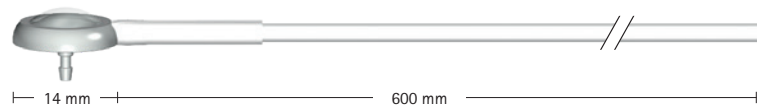
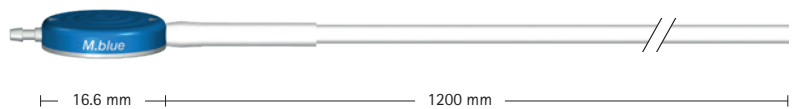

pediatric SPRUNG RESERVOIR*

M.blue®

Art. no.	Differential pressure unit	Adjustable gravitational unit
FX835T	0 cmH ₂ O	0 - 40 cmH ₂ O
FX836T	5 cmH ₂ O	0 - 40 cmH ₂ O
FX837T	10 cmH ₂ O	0 - 40 cmH ₂ O
FX838T	15 cmH ₂ O	0 - 40 cmH ₂ O

M.blue plus®



SHUNT SYSTEM WITH PEDIATRIC SPRUNG RESERVOIR

- M.blue plus® valve with distal catheter

- Pediatric SPRUNG RESERVOIR with distal catheter

* An additional valve in the inlet of the pediatric SPRUNG RESERVOIR makes it possible to pump cerebrospinal fluid in the direction of drainage only, allowing inspection of both the distal drainage section as well as the ventricular catheter.

- Ventricular catheter with introducing stylet

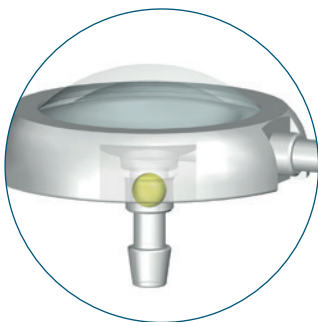
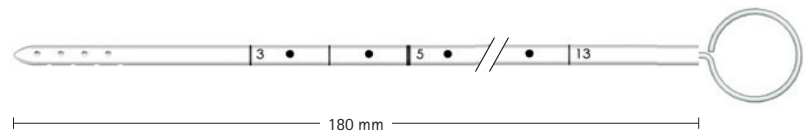
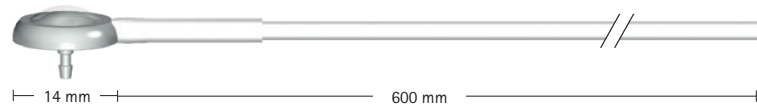
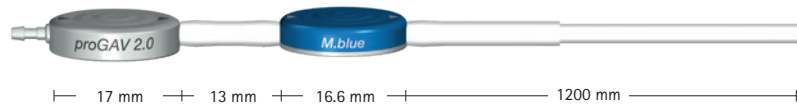

pediatric SPRUNG RESERVOIR*

M.blue plus®

Art. no.	Adj. differential pressure unit	Adjustable gravitational unit
FX839T	0 - 20 cmH ₂ O	0 - 40 cmH ₂ O

M.blue®

SHUNT SYSTEM WITH SPRUNG RESERVOIR

- M.blue® valve with distal catheter

- SPRUNG RESERVOIR with distal catheter

* An additional valve in the inlet of the SPRUNG RESERVOIR makes it possible to pump cerebrospinal fluid in the direction of drainage only, allowing inspection of both the distal drainage section as well as the ventricular catheter.

- Ventricular catheter with introducing stylet

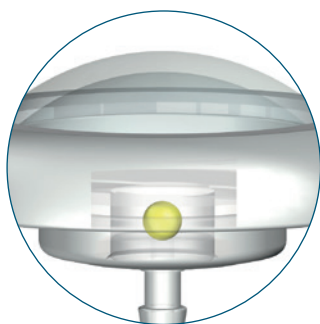
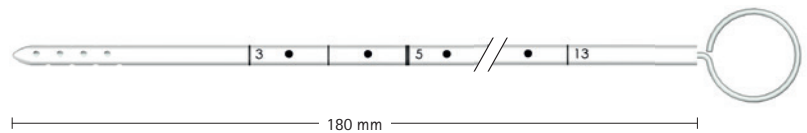
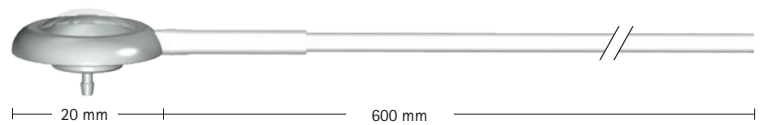
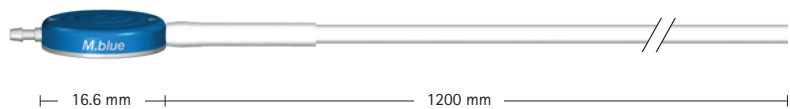

SPRUNG RESERVOIR*

M.blue®

Art. no.	Differential pressure unit	Adjustable gravitational unit
FX840T	0 cmH ₂ O	0 - 40 cmH ₂ O
FX841T	5 cmH ₂ O	0 - 40 cmH ₂ O
FX842T	10 cmH ₂ O	0 - 40 cmH ₂ O
FX843T	15 cmH ₂ O	0 - 40 cmH ₂ O

M.blue plus®

SHUNT SYSTEM WITH SPRUNG RESERVOIR



- M.blue plus® valve with distal catheter

- SPRUNG RESERVOIR with distal catheter

* An additional valve in the inlet of the SPRUNG RESERVOIR makes it possible to pump cerebrospinal fluid in the direction of drainage only, allowing inspection of both the distal drainage section as well as the ventricular catheter.

- Ventricular catheter with introducing stylet

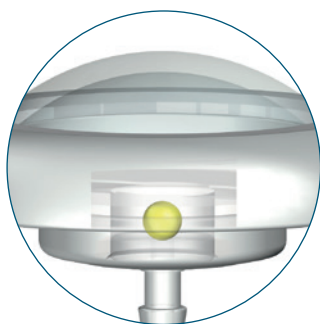
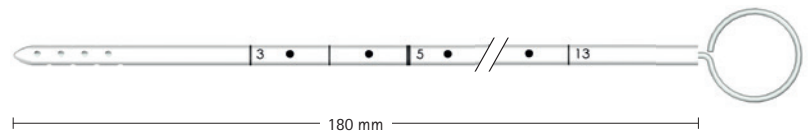
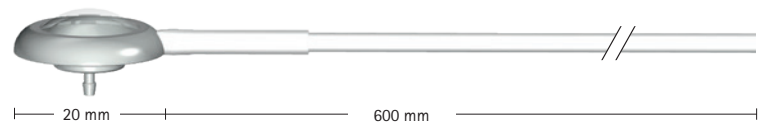
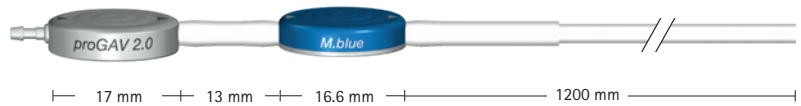

SPRUNG RESERVOIR*

M.blue plus®

Art. no.	Adj. differential pressure unit	Adjustable gravitational unit
FX844T	0 - 20 cmH ₂ O	0 - 40 cmH ₂ O

- M.blue® valve with distal catheter
- Pediatric burrhole reservoir with distal catheter
- Ventricular catheter with introducing stylet

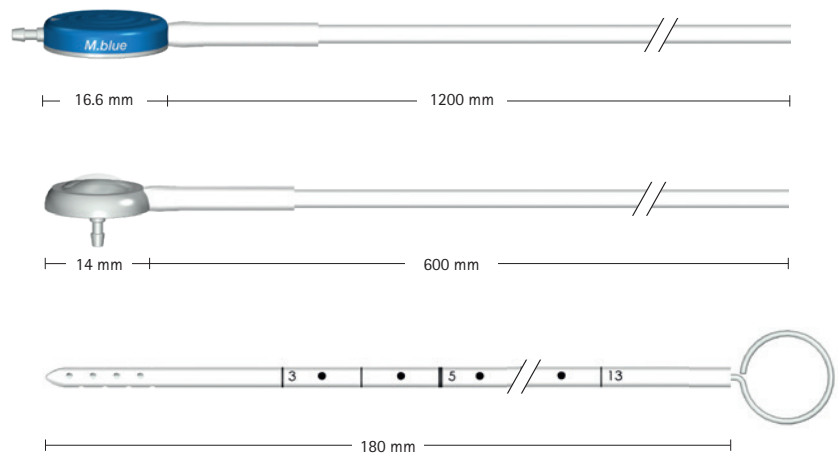

M.blue®

Art. no.	Differential pressure unit	Adjustable gravitational unit
FX845T	0 cmH ₂ O	0 - 40 cmH ₂ O
FX846T	5 cmH ₂ O	0 - 40 cmH ₂ O
FX847T	10 cmH ₂ O	0 - 40 cmH ₂ O
FX848T	15 cmH ₂ O	0 - 40 cmH ₂ O

SHUNT SYSTEM WITH PEDIATRIC BURRHOLE RESERVOIR

- M.blue plus® valve with distal catheter

- Pediatric burrhole reservoir with distal catheter

- Ventricular catheter with introducing stylet

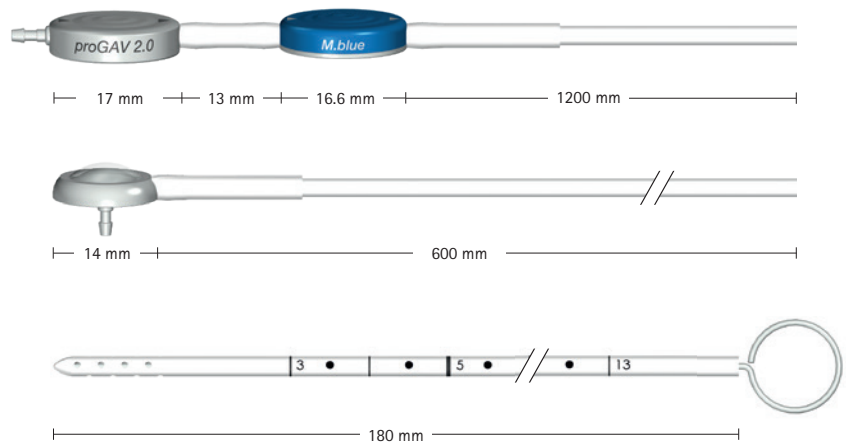

M.blue plus®

Art. no.	Adj. differential pressure unit	Adjustable gravitational unit
FX849T	0 - 20 cmH ₂ O	0 - 40 cmH ₂ O

M.blue plus® INSTRUMENTS

SOFT TOUCH INSTRUMENTS

- M.blue plus® instrument set
- M.blue plus® compass
- M.blue plus® adjustment ring
- M.blue plus® adjustment assistant
- M.blue® adjustment check-mate

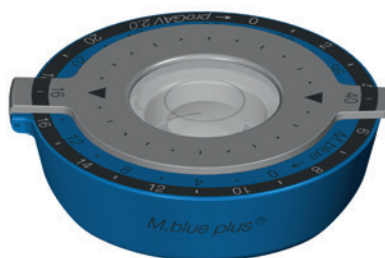

M.blue plus® compass

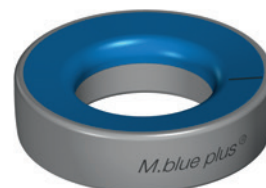

M.blue plus® adjustment ring



M.blue plus® adjustment assistant



M.blue® adjustment check-mate

Art. no.	Instruments
FX890T	M.blue plus® instrument set (includes FX891T and FX892T)
FX891T	M.blue plus® compass
FX892T	M.blue plus® adjustment ring
FX893T	M.blue plus® adjustment assistant
FX894T	M.blue® adjustment check-mate

OUR PRODUCTS – YOUR SELECTION

<i>M.blue</i> [®]	<i>proGAV</i> [®] 2.0	<i>GAV</i> [®] 2.0	<i>SHUNT-ASSISTANT</i> [®] 2.0	<i>DUALSWITCH VALVE</i>	<i>miniNAV</i> [®]	Accessories
						
Description						
Adjustable gravitational unit with integrated differential pressure valve unit	Adjustable differential pressure valve with gravitational unit	Gravitational valve for treating hydrocephalus	"Add-on" gravitational valve for preventing complications due to excess drainage	Gravitational valve with large flow volumes for CSF	Differential pressure valve, specifically for premature babies and newborns or bedridden, non-mobile patients	

Indication

LP		✓	✓	✓		
NPH	✓	✓	✓			
Ped. HC	✓	✓	✓		✓	
Adult HC	✓	✓	✓	✓	✓	

Patient

Bed ridden	✓				✓	
Active	✓	✓	✓	✓	*	

Characteristic

3-Tesla MR Conditional	✓	✓	✓	✓	✓	✓
Gravitational unit	✓	✓	✓	✓		
Adjustable	✓	✓				

* in conjunction with SHUNTASSISTANT[®] 2.0 or proSA[®]

REFERENCES

- (1) Lutz BR, Venkataraman P, Browd SR. New and improved ways to treat hydrocephalus: Pursuit of a smart shunt. *Surg Neurol Int.* 2013;4(Suppl 1):38–50.
- (2) Merkle AE, Chang J, Parker WE, et al. The Rate of Complications after Ventriculoperitoneal Shunt Surgery. *World Neurosurg.* 2017;98:654–8.
- (3) Beuriat PA, Puget S, Cinalli G, et al. Hydrocephalus treatment in children: long-term outcome in 975 consecutive patients. *J Neurosurg Pediatr.* 2017;20(1):10–8.
- (4) Drake JM, Kestle JR, Milner R, et al. Randomized trial of cerebrospinal fluid shunt valve design in pediatric hydrocephalus. *Neurosurgery.* 1998;43(2):294–303; discussion 303–5.
- (5) Pollack IF, Albright AL, Adelson PD. A randomized, controlled study of a programmable shunt valve versus a conventional valve for patients with hydrocephalus. *Hakim-Medos Investigator Group. Neurosurgery.* 1999;45(6):1399–408; discussion 408–11.
- (6) Browd SR, Ragel BT, Gottfried ON and Kestle JR. Failure of cerebrospinal fluid shunts: part I: Obstruction and mechanical failure. *Pediatr Neurol.* 2006;34(2):83–92,5.
- (7) Woerdeman PA, Cochrane DD. Disruption of silicone valve housing in a Codman Hakim Precision valve with integrated Siphoguard. *J Neurosurg Pediatr.* 2014;13(5):532–5.
- (8) Anderson RC, Walker ML, Viner JM, et al. Adjustment and malfunction of a programmable valve after exposure to toy magnets. Case report. *J Neurosurg.* 2004;101(2 Suppl):222–5.
- (9) Ozturk S, Cakin H, Kurtuldu H, et al. Smartphones and Programmable Shunts: Are These Indispensable Phones Safe and Smart? *World Neurosurg.* 2017;102:518–25.
- (10) Spader HS, Ratanaprasatporn L, Morrison JF, et al. Programmable shunts and headphones: Are they safe together? *J Neurosurg Pediatr.* 2015;16(4):402–5.
- (11) Strahle J, Selzer BJ, Muraszko KM, et al. Programmable shunt valve affected by exposure to a tablet computer. *J Neurosurg Pediatr.* 2012;10(2):118–20.
- (12) Zuzak TJ, Balmer B, Schmidig D, et al. Magnetic toys: forbidden for pediatric patients with certain programmable shunt valves? *Childs Nerv Syst.* 2009;25(2):161–4.
- (13) Irving G, Neves AL, Dambha-Miller H, et al. International variations in primary care physician consultation time: a systematic review of 67 countries. *BMJ Open.* 2017;7(10):e017902.
- (14) Powell A, Savin S, Savva N. Physician Workload and Hospital Reimbursement: Overworked Physicians Generate Less Revenue per Patient. *Manufacturing & Service Operations Management.* 2012;14(4):512–28.
- (15) Tschan CA, Antes S, Huthmann A, et al. Overcoming CSF overdrainage with the adjustable gravitational valve proSA. *Acta Neurochir (Wien).* 2014;156(4):767–76; discussion 776.
- (16) Suchorska B, Kunz M, Schniepp R, et al. Optimized surgical treatment for normal pressure hydrocephalus: comparison between gravitational and differential pressure valves. *Acta Neurochir (Wien).* 2015;157(4):703–9.
- (17) Golz L, Lemcke J, Meier U. Indications for valve-pressure adjustments of gravitational assisted valves in patients with idiopathic normal pressure hydrocephalus. *Surg Neurol Int.* 2013;4:140.
- (18) Lemcke J, Meier U, Muller C, et al. Safety and efficacy of gravitational shunt valves in patients with idiopathic normal pressure hydrocephalus: a pragmatic, randomised, open label, multicentre trial (SVASONA). *J Neurol Neurosurg Psychiatry.* 2013;84(8):850–7.
- (19) Sprung C, Schlosser HG, Lemcke J, et al. The adjustable proGAV shunt: a prospective safety and reliability multicenter study. *Neurosurgery.* 2010;66(3):465–74.
- (20) Thomale UW, Gebert AF, Haberl H, et al. Shunt survival rates by using the adjustable differential pressure valve combined with a gravitational unit (proGAV) in pediatric neurosurgery. *Childs Nerv Syst.* 2013;29(3):425–31.
- (21) Xinxing L, Hongyu D, Yunhui L. Using individualized opening pressure to determine the optimal setting of an adjustable proGAV shunt in treatment of hydrocephalus in infants. *Childs Nerv Syst.* 2015;31(8):1267–71.
- (22) Chari A, Czosnyka M, Richards HK, Pickard JD, Czosnyka ZH. Hydrocephalus shunt technology: 20 years of experience from the Cambridge Shunt Evaluation Laboratory. *J Neurosurg.* 2014;120(3):697–707.
- (23) Gebert AF, Schulz M, Schwarz K, et al. Long-term survival rates of gravity-assisted, adjustable differential pressure valves in infants with hydrocephalus. *J Neurosurg Pediatr.* 2016;17(5):544–51.
- (24) Toma AK, Watkins LD. Surgical management of idiopathic normal pressure hydrocephalus: a trial of a trial. *Br J Neurosurg.* 2016;30(6):605.



NEUROSURGERY

WE UNDERSTAND THE GRAVITY OF THE SITUATION.

GRAVITATIONAL VALVES BY MIETHKE

AESCULAP® – a B. Braun brand

Distributed by

Aesculap AG | Am Aesculap-Platz | 78532 Tuttlingen | Germany

Phone +49 7461 95-0 | Fax +49 7461 95-2600 | www.aesculap.com

AESCULAP® – a B. Braun brand

Manufacturer acc. to MDD 93/42/EEC

Christoph Miethke GmbH & Co. KG | Ulanenweg 2 | 14469 Potsdam | Germany

Phone +49 331 62083-0 | Fax +49 331 62083-40 | www.miethke.com

The product trademarks "GAV", "M.blue", "M.blue plus", "miniNAV", "proGAV", "proSA" and "SHUNTASSISTANT" are registered trademarks of Christoph Miethke GmbH & Co. KG in the majority of the world. For more detailed information please contact us: info@miethke.com. The main product trademark "Aesculap" is a registered trademark of Aesculap AG.

Subject to technical changes. All rights reserved. This brochure may only be used for the exclusive purpose of obtaining information about our products. Reproduction in any form partial or otherwise is not permitted.