



PRESCRIPTION

PATIENT ACCESS

PREPARATION

APPLICATION

DISCHARGE
MANAGEMENT

IV ACCESSORIES

THE SOURCE FOR SAFETY AND SIMPLICITY

Standard Extension Lines

Lines for every day



USER BENEFITS

- Type Heidelberger
 - 3.0 mm inner tubing
 - Available in different lengths
 - No limited flow-rate for all standard applications
-

Perfusor® Extension Lines

Lines for your syringe pump

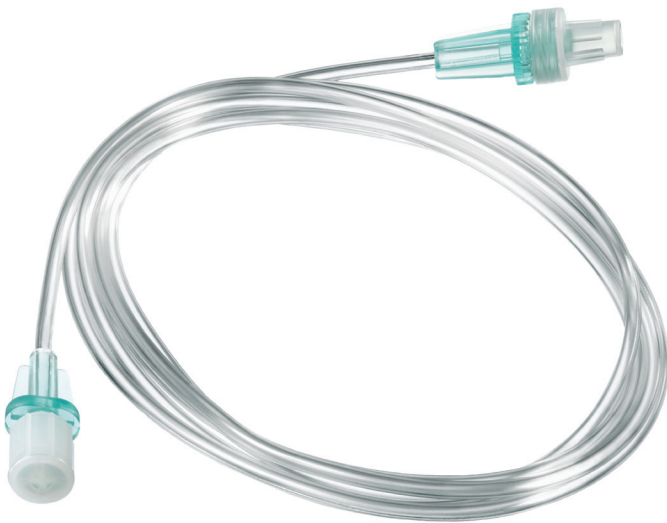

USER BENEFITS

Original Perfusor® Syringes & IV Lines set the benchmark for accuracy and long term consistency in infusion therapy

- Pressure proof up to 2 Bar
 - A landmark for high performance
 - Low absorption characteristics for the use with high potent drugs
 - Available in different lengths and materials
-

Discofix[®] C – Stopcocks

Your access to premium safety



Drug resistant material

- Helps to prevent leakage, contamination and air-embolism resulting from stress cracks
- Reduces number of set changes

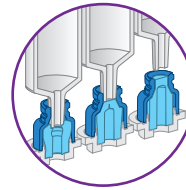

Self closing port

- Prevents drug exposure
- Is designed to protect against chemical contamination
- Eliminates caps



Valve with smooth surface

- Is designed to protect against microbiological contamination

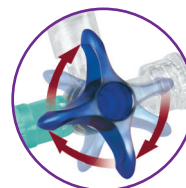

Light snap at every 45° turn of the handle

- Makes accurate adjustments quick and easy

Discofix[®] C – Manifolds

Your access to premium safety

- Allows convenient access for injections and aspirations by rotating adapter
- Resists the hazardous effects of pharmaceuticals
- Let you feel the proper setting by tactile response at every 45° turn

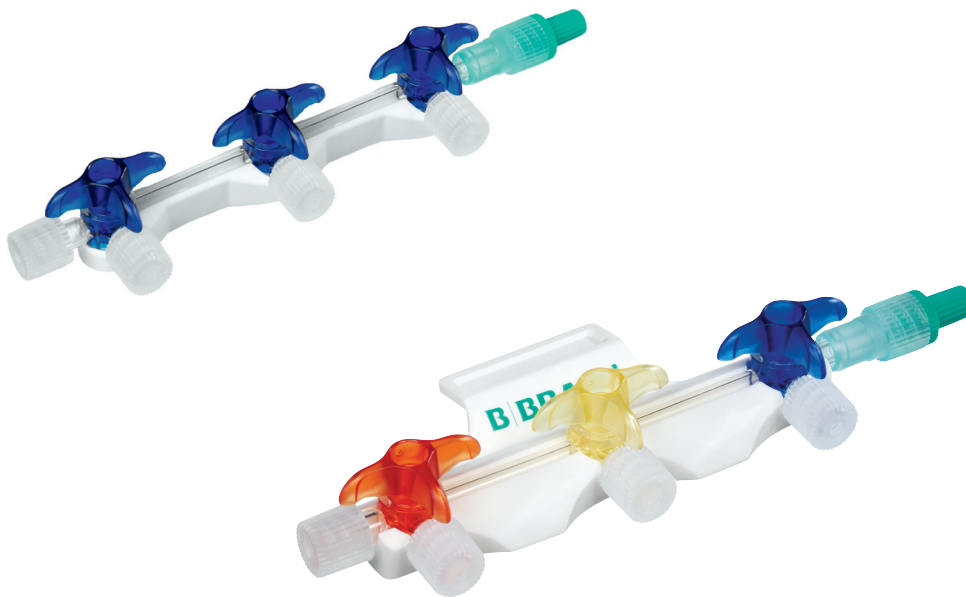

- Maintains a leakproof connection even during long-term application
- Helps to prevent leakage, contamination and air embolism

Filters

Prevention is the best protection

Prominent risks of particulate contamination

- impairment of microcirculation
- blockages of blood vessels damage of various organs
- phlebitis

Apart of harming patients this leads to additional treatment costs as well as extended duration of hospital stays.

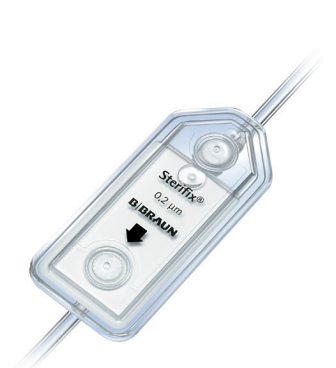
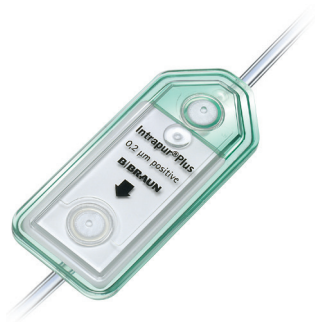

USER BENEFITS

- Retention of particles and microorganisms
 - Protection from air embolism
 - Detection of incompatibilities
 - Less complications
 - Reduction of length of stay on the ICU
 - Reduction of ventilation time
 - Cost saving
-

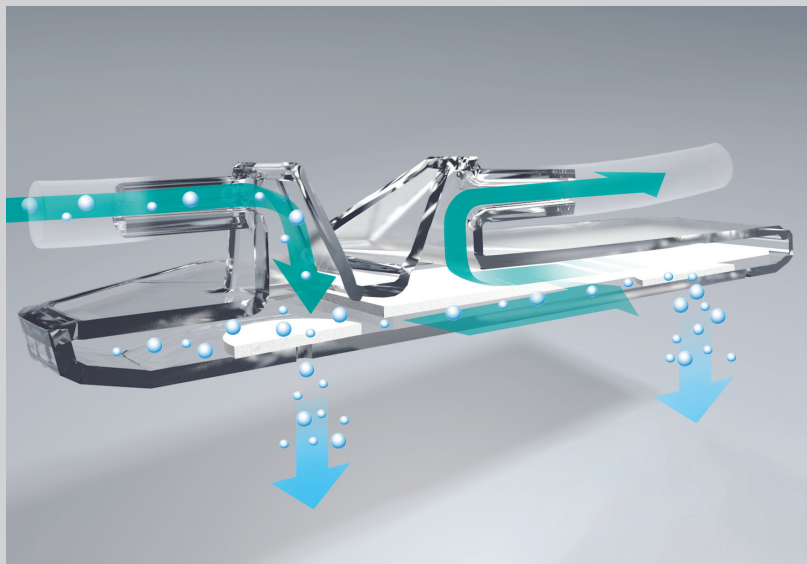
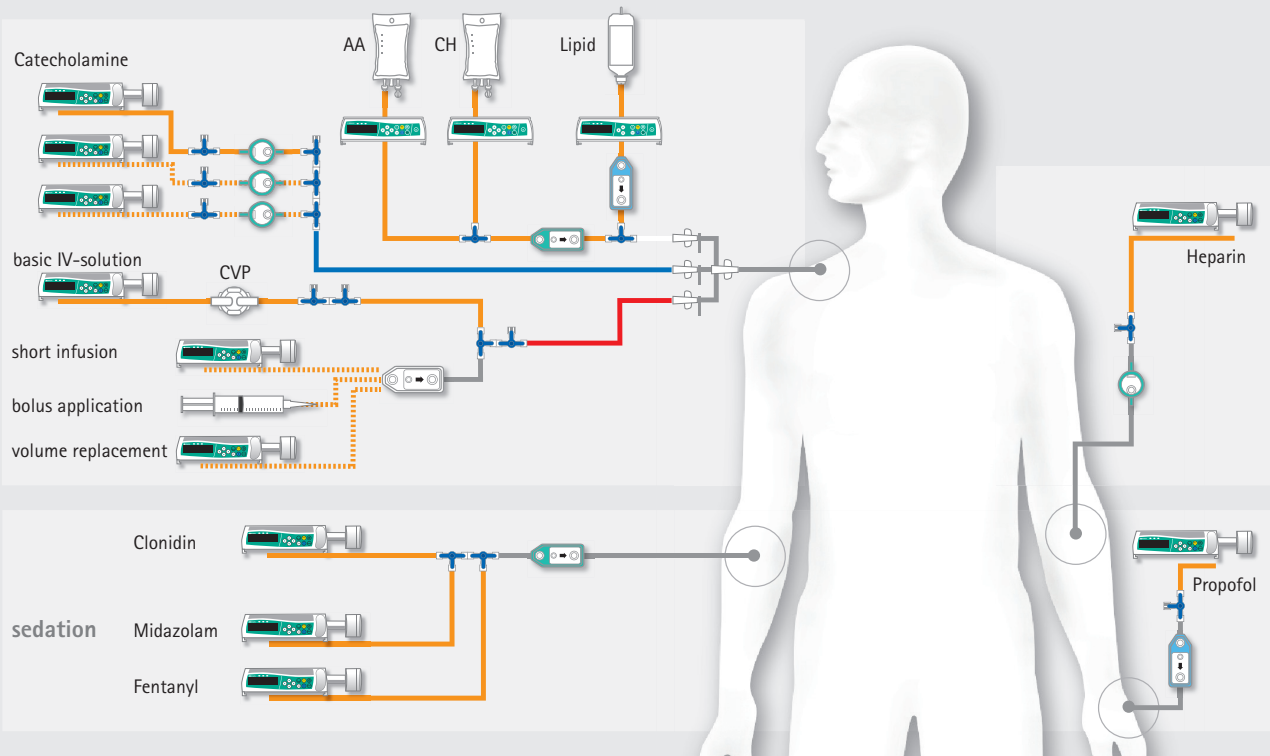

Caresite[®] – Needle-free connector

The valve that makes infusion safety simple



Easy to visually inspect



Easy to grip



Easy to clean



Easy to connect



USER BENEFITS

Protects against microbiological contamination:

- Smooth, swabbable surface
- Clear
- Open fluid path

Prevents catheter occlusion

- Positive displacement (valve design)

Ease of use

- High pressure resistant
 - Easy to access
 - Drug compatible**
-

** lipids and cremophor

Safeflow - Needle-free connector

The valve that makes infusion safety simple



PVC/DEHP-free Neutrapur® tubing

- Particularly patient-friendly
- No plasticizer leachable
- Ecological disposal



Rotating Luer-Lock connector

- Permits safer and more convenient connection without twisting the tube



Safeflow valve

- Offers convenient and safe needle-free access for injection, aspiration or parallel infusions as a closed system



Back check valve

- Prevents backflow and therefore it offers higher safety during parallel pressure and gravity infusions.

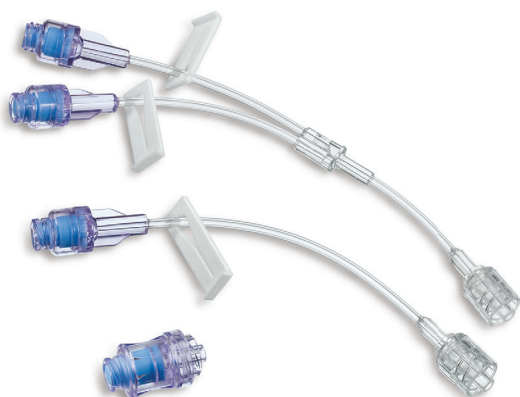

USER BENEFITS

- Swabbable
 - Compatible with Luer-Slip and Luer-Lock
 - Allows multiple access for direct aspiration or fluid injection
 - Suitable for all IV Systems
-

ProSet Spiral Extension lines

More flexibility for your patients

HOSPITAL BENEFITS



Time saving



Reduction of overall process costs



Less assembly errors



Waste reduction through less packaging



Reduction of contamination risk



Increased safety through standardization

USER BENEFITS



Lower risk of contamination



Optimized work processes relieve the burden of the nursing staff



Ready-to-use customized sets



Safety through standardization

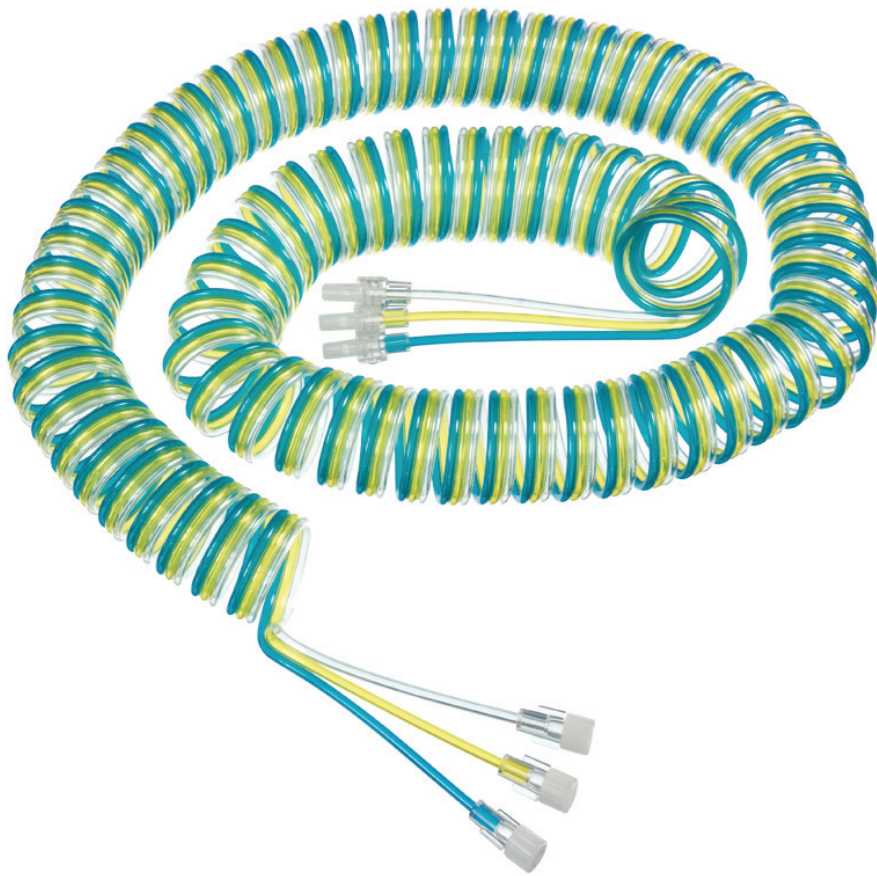

Omnifix® Luer Solo Syringes

3-Piece Syringes with Luer Connector

PRODUCT FEATURES

- Highly transparent barrel
- High contrast graduation
- Integrated plunger backstop (1)
- Graduation extended beyond nominal volume for 2 ml, 10 ml and 50 ml
- Luer connector
- Barrel and plunger made of polypropylene
- Rubber piston with double sealing ring made of polyisoprene
- Not manufactured with PVC, Latex and DEHP
- Sterile single packaging
- Box of 100 pcs

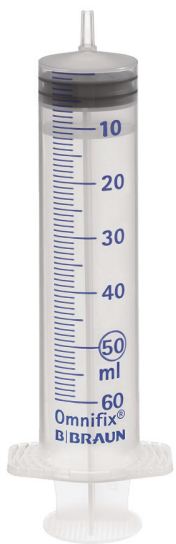

USER BENEFITS

- Highly transparent barrel with high contrast graduation for easy reading and exact dosing
 - Rubber piston with double sealing ring allows slow aspiration and injection
 - Safe plunger backstop to prevent unintentional plunger withdrawal
-

Omnifix® Luer Lock Solo Syringes

3-Piece Syringes with Luer Lock Connector

PRODUCT FEATURES

- Highly transparent barrel
- High contrast graduation
- Integrated plunger backstop (1)
- Graduation extended beyond nominal volume for 2 ml, 10 ml and 50 ml
- Luer Lock connector
- Barrel and plunger made of polypropylene
- Rubber piston with double sealing ring made of polyisoprene
- Not manufactured with PVC, Latex and DEHP
- Sterile single packaging
- Box of 100 pcs



USER BENEFITS

- Highly transparent barrel with high contrast graduation for easy reading and exact dosing
 - Rubber piston with double sealing ring allows slow aspiration and injection
 - Safe plunger backstop to prevent unintentional plunger withdrawal
 - Released for using in combination with compatible pump sizes 2 to 50 ml syringes with Luer Lock cone
-

Original Perfusor® Syringes

3-Piece Syringes for Use with Perfusor® Syringe Pumps

PRODUCT FEATURES

- Highly transparent barrel
- High contrast graduation
- Integrated plunger backstop (1)
- Barrel and plunger made of polypropylene
- Luer Lock connector
- Not manufactured with PVC, Latex and DEHP
- Sterile single packaging
- Rubber piston with double sealing ring made of bromobutyl (20 ml) and polyisoprene (50 ml)
- Syringe with and without bi-packed needle



USER BENEFITS

- Released to be used for long term infusions by compatible infusion pumps
 - High contrast graduation for easy reading
 - Versions with and without aspiration or filter needle
 - Rubber piston with double sealing ring allows slow aspiration and injection
 - Safe plunger backstop to prevent unintentional plunger withdrawal
 - UV-protect syringe, 50 ml (orange colored barrel) for light sensitive medications
-

Enteral Syringes

Syringes with ENFit® Connector for Enteral Applications

PRODUCT FEATURES

- Enteral syringe with female ENFit® connector
- Purple plunger
- Highly transparent barrel
- High contrast black graduation
- Integrated plunger backstop (1)
- Only connectable to male ENFit® connector (IV incompatible)
- Barrel and plunger made of polypropylene
- Not manufactured with PVC, Latex, DEHP and BPA
- Sterile single packaging







USER BENEFITS

- Purple plunger for visual differentiation from conventional and NRFit® syringes
 - Purple color coding allows faster identification of enteral devices
 - Dedicated enteral connectors to minimize risk of misconnections
 - ‚Lock and Key‘ feature ensures secure connection
 - Highly transparent barrel with high contrast black graduation for easy reading and precise dosing
 - Low dose tip on the 1ml, 2.5ml and 5ml syringe sizes
-

Standard Extension lines

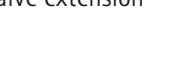

Lines for every day

Extension line Type Heidelberg	Length (cm)	Priming Volume (ml)	Inner Ø (mm)	Material	Sales unit / Pcs.	Code No. (REF)
	30	2.1	3.0	PVC (DEHP-free)	100	4097300
	75	5.3	3.0	PVC (DEHP-free)	100	4097173
	100	7.1	3.0	PVC (DEHP-free)	100	4097262
	140	9.9	3.0	PVC (DEHP-free)	100	4097408
	190	13.4	3.0	PVC (DEHP-free)	100	4097190
	320	22.6	3.0	PVC (DEHP-free)	100	4097130



Extension line Type Heidelberg	Length (cm)	Priming Volume (ml)	Inner Ø (mm)	Material	Sales unit / Pcs.	Code No. (REF)
LS-2 connector 	15	1.6	3.0	PVC (DEHP-free)	100	4097122
LS-4 connector 	35	4.5	3.0	PVC (DEHP-free)	100	4097149
LS-5 connector 	35	2.5	3.0	PVC (DEHP-free)	100	4097157
Connection tubing with injection port 	14	1.12	3.0	PVC (DEHP-free)	100	4247116
Back-check valve extension set 	20	1.8	3.0	DEHP-free	100	471980

Perfusor® Extension lines

Lines for your syringe pump

Original Perfusor® Lines PVC	Length (cm)	Priming Volume (ml)	Inner Ø (mm)	Material	Sales unit / Pcs.	Code No. (REF)
	50	1.3	1.5	PVC (DEHP-free)	100	8255172
	150	2.9	1.5	PVC (DEHP-free)	100	8722960
	200	3.8	1.5	PVC (DEHP-free)	100	8722862
	250	4.8	1.5	PVC (DEHP-free)	100	8755490
	300	5.7	1.5	PVC (DEHP-free)	100	8255253
	75	0.6	0.9	PVC (DEHP-free)	100	8722870
	150	1.1	0.9	PVC (DEHP-free)	100	8255504

Original Perfusor® Lines PE	Length (cm)	Priming Volume (ml)	Inner Ø (mm)	Material	Sales unit / Pcs.	Code No. (REF)
	50	0.5	1.0	PE (PVC-free)	100	8255059
	100	0.9	1.0	PE (PVC-free)	100	8255067
	150	1.3	1.0	PE (PVC-free)	100	8722935
	200	1.7	1.0	PE (PVC-free)	100	8723060
	250	2.1	1.0	PE (PVC-free)	100	8272565
	300	2.5	1.0	PE (PVC-free)	100	8250146

Original Perfusor® Lines with Light Protection	Length (cm)	Priming Volume (ml)	Inner Ø (mm)	Material	Sales unit / Pcs.	Code No. (REF)
	150	1.3	1.0	PVC (DEHP-free)	100	8723017
	200	1.7	1.0	PVC (DEHP-free)	100	8723018
	150	1.3	1.0	PVC (DEHP-free)	100	8723010

Special Extension lines

More flexibility for each therapy

Original Perfusor® Lines with Safesite® valve	Length (cm)	Priming Volume (ml)	Inner Ø (mm)	Material	Sales unit / Pcs.	Code No. (REF)
	150	3.3	1.5	PVC (DEHP-free)	100	8722820

Original Perfusor® Line with Sterifix® 0.2 µm particle filter	Length (cm)	Priming Volume (ml)	Inner Ø (mm)	Material	Sales unit / Pcs.	Code No. (REF)
	200	4.8	1.5	PVC (DEHP-free)	50	8723001

Original Perfusor® Line Type Enteral Nutrition ENFit®	Length (cm)	Priming Volume (ml)	Inner Ø (mm)	Material	Sales unit / Pcs.	Code No. (REF)
	190	7.9	2.5	PVC (DEHP-free)	25	87229910

Original Perfusor® Line Type Epidural NRFit®	Length (cm)	Priming Volume (ml)	Inner Ø (mm)	Material	Sales unit / Pcs.	Code No. (REF)
	200	2.8	1.3	PUR (Neutrapur)	25	8722865

Spiral Extension lines

More flexibility for your patients

Spiral-Tubings	Colour	Length (cm)	Priming Volume (ml)	Inner Ø (mm)	Material	Sales unit / Pcs.	Code No. (REF)
	□	150	1.2	1.0	PUR	50	4092937
	□	150	4.7	2.0	PUR	50	4090365
	□	300	2.4	1.0	PUR	50	4092945
	■	300	2.4	1.0	PUR	50	4092946
	□	300	9.4	2.0	PUR	50	4090373
	□	500	3.9	1.0	PUR	50	4092953
	□	500	15.7	2.0	PUR	50	4090438
	□	700	5.5	1.0	PUR	50	4092961
	□	700	22	2.0	PUR	50	4090381
	■	700	22	2.0	PUR	50	4090383
	□	850	6.7	1.0	PUR	50	4092970
	□	850	26.7	2.0	PUR	50	4090390

ProSet Spiral Extension lines

More flexibility for your patients

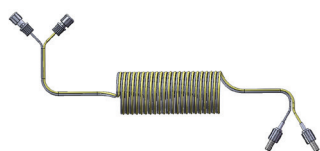

ProSet Spiral Lines	Colour	Length (cm)	Priming Volume (ml)	Inner Ø (mm)	Material	Sales unit / Pcs.	Code No. (REF)
	■ □	150	1.2	1.0	PUR	50	4091740
	■ □	300	2.4	1.0	PUR	50	4091752
	■ □	300	2.4	1.0	PUR	50	4091736
	■ □	300	9.4	2.0	PUR	50	4093830
	■ □	500	3.9	1.0	PUR	50	4099362
	■ □	500	3.9	1.0	PUR	50	4093585
	■ □	500	15.7	2.0	PUR	40	4093850
	■ □	700	5.5	1.1	PUR	50	4093607
	■ □	700	5.5	1.1	PUR	50	4091884
	■ □	700	22.0	2.0	PUR	30	4093870
	■ □	850	6.7	1.0	PUR	50	4091728
	■ □	850	26.7	2.0	PUR	25	4093885



ProSet Spiral Lines	Length (cm)	Priming Volume (ml)	Inner Ø (mm)	Material	Sales unit / Pcs.	Code No. (REF)
	150	1.2	1.0	PUR	50	4093115
	150	4.7	2.0	PUR	50	4093215
	300	2.3	1.0	PUR	50	4093130
	300	9.4	2.0	PUR	50	4093230
	500	3.9	1.0	PUR	50	4093150
	500	15.7	2.0	PUR	40	4093250
	700	5.5	1.0	PUR	50	4093170
	700	22.0	2.0	PUR	25	4093270
	850	6.7	1.0	PUR	50	4093185
	850	26.7	2.0	PUR	25	4093285

Discofix® C – Manifolds

Your access to premium safety

Discofix® C Manifolds with fixation plate	Colour	Rotating adapter	Proximal stopcock	Extension (cm)	Extension DEHP-free	Sales unit/ pcs.	Code No. (REF)
	■ ■ ■	■				50	16600C
	■ ■ ■	■				50	16605C
	■ ■ ■	■		75 cm	■	50	4085213
	■ ■ ■	■	■	180 cm	■	50	16611C
	■ ■ ■	■		200 cm	■	50	4085168
	■ ■ ■	■	■	150 cm	■	50	16610C
	■ ■ ■	■		150 cm	■	50	16615C
	■ ■ ■ ■ ■ ■	■				40	16608C
	■ ■ ■ ■ ■ ■	■				40	16609C
	■ ■ ■ ■ ■ ■	■		150 cm	■	40	16612C
	■ ■ ■ ■ ■ ■	■	■	150 cm	■	40	16613C
	■ ■ ■ ■ ■ ■	■		100 cm	■	40	4085230
	■ ■ ■ ■ ■ ■	■	■	180 cm	■	40	16614C
	■ ■ ■ ■ ■ ■	■		200 cm	■	40	4083777

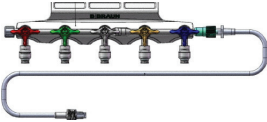

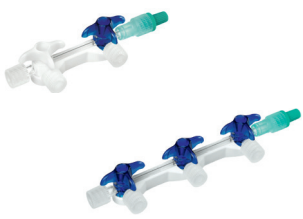











Discofix® C Closed System	Colour	Rotating adapter	Proximal stopcock	Extension (cm)	Extension DEHP-free	Sales unit/ pcs.	Code No. (REF)
	■ ■ ■	■				50	4085300SF
	■ ■ ■ ■ ■ ■	■				40	4085500SF
	■ ■ ■	■		150 cm	■	50	4085434SF
	■ ■ ■ ■ ■ ■	■		150 cm	■	50	4085450SF

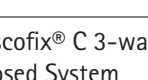



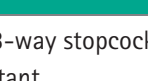

Discofix® C Manifolds	Colour	Rotating adapter	Proximal stopcock	Extension (cm)	Extension DEHP-free	Sales unit/pcs.	Code No. (REF)
	■ ■	■				50	16800C
	□ ■	■				50	16801C
	■ ■ ■	■				50	16900C
	■ ■ ■ ■	■				50	16901C

Combi-Holder	Product description	Sales unit/pcs.	Code No. (REF)
	Combi-holder, suitable for stopcocks manifolds and Medifix® manometer scale.	1	4086007

Discofix® - Stopcocks











Your access to premium safety



Stopcocks - Drug resistant	Colour	Rotating adapter	Extension (cm)	Extension DEHP-free	Sales unit/ pcs.	Code No. (REF)
Discofix® C 3-way stopcock	■	■			100	16494C
	□	■			100	16495C
	■	■			100	16496C
	■	■			100	16497C
	■	■	10 cm	■	50	16500C
	□	■	10 cm	■	50	16501C
	■	■	25 cm	■	50	16520C
	■	■	50 cm	■	50	16540C
	■	■	75 cm	■	50	16551C
	■	■	100 cm	■	50	16560C
Discofix® C 3-way stopcock Closed System	■	■			100	16494CSF
	□	■			100	16495CSF
	■	■	10	■	50	16500CSF
	□	■	10	■	50	16501CSF
	■	■	25	■	50	16520CSF
	■	■	50	■	50	16540CSF
	■	■	75	■	50	16551CSF
	■	■	100	■	50	16560CSF

Stopcocks - Lipid Resistant	Colour	Rotating adapter	Extension (cm)	Extension DEHP-free	Sales unit/ pcs.	Code No. (REF)
Discofix® 3-way stopcock Lipid Resistant	■	■			200	4095111
	■	■			200	4095120
	□	■			200	4095146
	■	■	10	■	100	4098102
	■	■	25	■	100	4098218
	■	■	50	■	100	4098501
	■	■	75	■	100	4098234
	■	■	100	■	100	4098080

Filters

Prevention is the best protection

Product	Pore size	Filtration area (cm ²)	Flow rate (aqua dist., ml/min)	Filling volume		Tubing diameters	Time of use recommended	Sales unit/ pcs.	Code No. (REF)
				Filter (ml)	Total (ml)				
Product description	<ul style="list-style-type: none"> ■ Positively charged ■ Bacteria retention 		<ul style="list-style-type: none"> ■ Endotoxin retention ■ Fungi retention 		<ul style="list-style-type: none"> ■ Particulate retention ■ Air elimination 				
Intrapur® Plus 	0.2 µm	10	> 20	2.4	3.46	PVC 2 x 4.1	96 h	50	4099800
Intrapur® Plus 	0.2 µm	10	> 20	2.4	4.54	PUR 3 x 4.1	96 h	50	4183916
Intrapur® Paed	0.2 µm	4.5	> 10	0.7	1.19	PVC 1.2 x 2.2	96 h	50	4099753
Intrapur® Neonat	0.2 µm	1.65	> 2	0.4	0.76	PUR 1 x 2.35	96 h	50	4099451
Product description	<ul style="list-style-type: none"> ■ Low protein binding ■ Fungi retention 		<ul style="list-style-type: none"> ■ Particulate retention ■ Air elimination 						
Intrapur® Lipid 	1.2 µm	10	> 100	2.4	3.46	PVC 2 x 4.1	24 h	50	4099702
Intrapur® Paed Lipid 	1.2 µm	4.5	> 90	0.7	-	no tubing	24 h	50	4093216
Intrapur® Paed Lipid 	1.2 µm	4.5	> 90	0.7	1.19	PVC* 1.2 x 2.2	24 h	50	4099850
Intrapur® Neonat Lipid 	1.2 µm	1.65	> 30	0.4	0.76	PUR 1 x 2.35	24 h	50	4099460
Product description	<ul style="list-style-type: none"> ■ Low protein binding ■ Bacteria retention 		<ul style="list-style-type: none"> ■ Fungi retention ■ Particulate retention 		<ul style="list-style-type: none"> ■ Air elimination 				
Sterifix® 	0.2 µm	10	> 20	2.4	3.46	PVC 2 x 4.1	24 h	50	4099303
Sterifix® 	0.2 µm	10	> 20	2.4	4.54	PUR 3 x 4.1	24 h	50	4184637
Sterifix® Paed 	0.2 µm	4.5	> 10	0.7	-	no tubing	24 h	50	4099354
Sterifix® Neonat 	0.2 µm	1.65	> 2	0.4	0.76	PUR 1 x 2.35	24 h	50	4099257

Injection and Aspiration Filters	Particle retention	Bacteria retention	Special features	Pore size (µm)	Sales unit / Pcs.	Code No. (REF)
Sterifix® injection filter 	■	■	Suitable as syringe-filter	0.2	200	4099206
Sterifix® Pury 	■		Suitable as syringe-filter	5	100	4551001

Caresite® – Needle-free connector



The valve that makes infusion safety simple



Caresite®	Product description	Length (cm)	Priming Volume (ml)	Tubing Inner Ø (mm)	Latex free	DEHP free	Sales unit/Pcs.	Code No. (REF)
	Caresite®		0.22		■	■	100	415122-01

Caresite® Extension Sets	Product description	Length (cm)	Priming Volume (ml)	Tubing Inner Ø (mm)	Latex free	DEHP free	Sales unit/Pcs.	Code No. (REF)
	Small bore extension set with Caresite®, Spin-Lock (high pressure - for power injectors)	20	0.5	1.3	■	■	100	470100-01
	Standard bore extension set with Caresite®, Spin-Lock	15	0.9	2.8	■	■	100	470108-01
	Small bore Double extension set with 2 Caresite®, Spin-Lock	18	0.9	1.3	■	■	100	470106-01
	Small bore Double extension set with 2 Caresite®, 2 back-check valves, Spin-Lock	22	1.6	1.3	■	■	100	470182
	Small bore Triple extension set with 3 Caresite®, Spin-Lock	20	1.3	1.3	■	■	50	470160
	Small bore Triple extension set with 3 Caresite®, 3 back-check valves, Spin-Lock	22	2.0	1.3	■	■	50	470161
	Caresite® extension set with female and male Luer-Lock connectors, back-check valve and Caresite® Luer Access Device 10 cm above distal end	23	1.5	2.8	■	■	50	470183

Safeflow – Needle-free connector

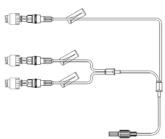

The valve that makes infusion safety simple

Safeflow	Product description	Length (cm)	Priming Volume (ml)	Tubing Inner Ø (mm)	Latex free	DEHP free	Sales unit/Pcs.	Code No. (REF)
	Safeflow valve, blue		0.09 ml		■	■	50	409100H
	Safeflow valve, red		0.09 ml		■	■	50	409110H

Safeflow Extension Sets	Product description	Length (cm)	Priming Volume (ml)	Tubing Inner Ø (mm)	Latex free	DEHP/ PVC free	Sales unit/Pcs.	Code No. (REF)
	Smallbore Extension Set with Safeflow valve	10	0.22	1.0	■	■	100	4097154N
	Smallbore Y-Extension Set with 2 Safeflow valves	12	0.38	1.0	■	■	100	4097145N
	Smallbore Y-Extension Set with 2 Safeflow valves and back-check valve	12	0.66	1.0	■	■	100	4097148N
	Smallbore Y-Extension Set with 3 Safeflow valves	15	0.60	1.0	■	■	50	4097146
	Smallbore Y-Extension Set with 3 Safeflow valves and back-check valve	15	1.02	1.0	■	■	50	4097147



Cones, adapters and back-check valves



The most reliable connectors for all therapy treatments







Closing Cones		Product description	Sales unit/ pcs.	Code No. (REF)
Combi-Stopper		■ Universal suitable to close female and male accesses	100	4495101
		■ Universal suitable to close female and male accesses	100	4495152
		□ Universal suitable to close female and male accesses	100	4495209
IN-Stopper		■ Injection port latex free	100	4238010
Stopper		Stopper Luer-Lock	100	4097076

Adapters		Product description	Sales unit/ pcs.	Code No. (REF)
Combifix®		Female/female	100	5206634
		Male/male	100	5206642
		Luer female/Rekord female	100	4090306

Venting Systems		Product description	Sales unit/ pcs.	Code No. (REF)
Aeration cannula		1.1 x 30 mm with bacteria retentive filter	100	4190050

Back-check valves	Product description	Sales unit/ pcs.	Code No. (REF)
	Infuvalve®	50	4094000N
	Anti-siphon valve	100	415062

PureSites	Product description	Sales unit/ pcs.	Code No. (REF)
	Closed male connector	100	4551100
	Dust cover cap	200	4551101

Flush & Disinfect Solutions	Product description	Volume	Sales unit/ pcs.	Code No. (REF)
	SwabCap® Valve Cap with 70% IPA	-	200	EM-SCXT3
	SwabPack® - 10 x SwabCap® Valve Cap with 70% IPA	-	250	EM-SCXT3-10
	SwabPack® - 25 x SwabCap® Valve Cap with 70% IPA	-	300	EM-SCXT3-25
	Omniflush® with SwabCap® 10 ml in 10 ml	10 ml 0.9% Sodium Chloride (NaCl)	100	EM-3513576SC
	Omniflush® with SwabCap® 5 ml in 10 ml	5 ml 0.9% Sodium Chloride (NaCl)	100	EM-3513575SC
	Omniflush® with SwabCap® 3 ml in 10 ml	3 ml 0.9% Sodium Chloride (NaCl)	100	EM-3513572SC

Syringes

Luer Lock & Luer Slip

Omnifix® Syringes Luer Slip	Description	Volume	Graduation	Sales Unit/Pcs	Code No. (REF)
	Omnifix® Luer Solo - Luer Slip	2 ml	0.1 ml	100	4616022V
		5 ml	0.2 ml	100	4616057V
		10 ml	0.5 ml	100	4616103V
		20 ml	1.0 ml	100	4616200V
		30 ml	1.0 ml	100	4616308F
		50 ml	1.0 ml	100	4616502F

Omnifix® Syringes Luer Lock	Description	Volume	Graduation	Sales Unit/Pcs	Code No. (REF)
	Omnifix® Luer Solo - Luer Lock	2 ml	0.1 ml	100	4617029V
		5 ml	0.2 ml	100	4617053V
		10 ml	0.5 ml	100	4617100V
		20 ml	1.0 ml	100	4617207V
		30 ml	1.0 ml	100	4617304F
		50 ml	1.0 ml	100	4617509F
	Omnifix® Luer Solo - Luer Lock Light protection up to 520 nm	50 ml	1.0 ml	100	4617510F-06

Syringes

Original Perfusor® and Enteral

Original Perfusor® Syringes	Description	Volume	Graduation	Sales Unit/Pcs	Code No. (REF)
	Without aspiration needle	20 ml	1 ml	50	8728615
	Incl. 30 mm needle, Ø 2 mm	20 ml	1 ml	50	8728623
	Without aspiration needle	50 ml	1 ml	100	8728844F-06
	Incl. 30 mm needle, Ø 2 mm	50 ml	1 ml	100	8728810F-06
	Incl. 28 mm 15µm filter needle, Ø 2 mm	50 ml	1 ml	100	8728852F-06
	Transparent light protection 520 nm, incl. 15 mm filter needle, Ø 2 mm	50 ml	1 ml	100	8728861F-06
	NRFit® connector, yellow plunger rod	50 ml	1 ml	100	8728845F-01

Enteral Syringes (type ENFit®)	Size	Cone	Graduation	Total Graduated Capacity	Sales Unit/Pcs	Code No. (REF)
	1 ml	Centric	0.01 ml	1.0 ml	200 pcs	4616024-01
	2.5 ml	Eccentric	0.10 ml	2.5 ml		4616025-01
	5 ml	Eccentric	0.10 ml	5.0 ml		4616026-01
	10 ml	Eccentric	0.10 ml	10.0 ml	100 pcs	4616027-01
	20 ml	Eccentric	1.00 ml	20.0 ml		4616028-01
	60 ml	Eccentric	1.00 ml	60.0 ml		4616029-01

B. Braun Medical N.V./S.A. | +32 (0)2 712 86 50 | customercare.be@bbraun.com | www.bbraun.be

The information contained in this communication is strictly confidential, may constitute inside information, and is intended only for the use of the addressee. It is the property of the sender of this information. Unauthorized use, disclosure, or copying of this communication or any part thereof is strictly prohibited and may be unlawful.