



reddot design award  
winner 2019



STERILE GOODS  
MANAGEMENT

# AESCULAP<sup>®</sup> SQ.line<sup>®</sup>

## REINVENTING SURGICAL INSTRUMENTS

# AESCULAP® SQ.line®

OUR MOTIVATION | YOUR SOLUTION

## WORK ERGONOMICALLY?

My muscles are tired after working all day in the physically demanding orthopedic theaters.

## ➤ THEN WORK ERGONOMICALLY!

The new SQ.line® instruments allow me to work ergonomically. Pressure points and joint stress are thus reduced.



## COMPLEX REPROCESSING?

Instruments with non-observable joints, narrow gaps and instruments made from different materials increase the complexity of my work – the Reprocessing.

## ➤ NOT ANYMORE!

Instruments now has to be less manually pre-cleaned. Careful cleaning of the SQ.line® instruments is more simplified and effective.



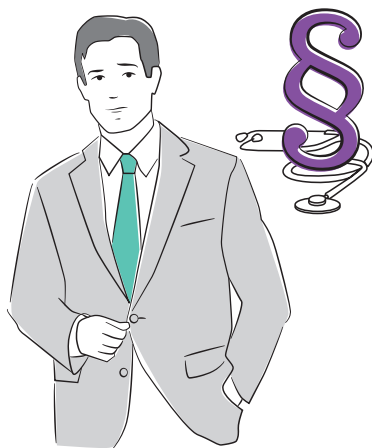

## BAD PRESS?

Postoperative wound infections contradict the mission statement of our clinic, which promises a high-quality patient care.

## ➤ NO THANKS!

Our efforts to reduce postoperative wound infections can be supported by SQ.line® instruments. Because the welfare and the satisfaction of our patients stand at the highest level.

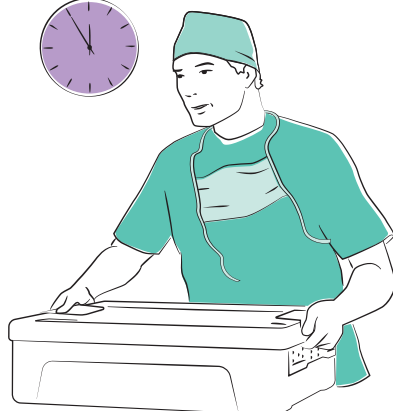

## TIME PRESSURE?

Inadequately reprocessed instruments can lead to delays and increase stress in the theatre department.

## ➤ RELAXED PROCEDURES!

Our efforts to ensure that the surgical procedure runs smoothly can be supported by SQ.line® instruments.

## ERGONOMIC WORKING

### ➤ FEEL THE GRIP

The unique design provides 70% more grip in comparison to previous products due to shape, material, edges and texture.

**The result: less force to achieve a safe grip during use.**

### ➤ DESIGN MAKES THE DIFFERENCE

Ergonomically designed instruments reduce pressure points and joint stress, so that the risk of related injuries is minimized.



Mallet AESFULAP®\*

\* Measurement of the surface pressure distribution with a pressure measuring foil.



reddot design award  
winner 2019



PATENT  
pending

### FINE TUNING

One-piece spring mechanism means there is no risk of screws loosening or accidental opening of the spring during use.

### FEEL COMFORTABLE

25% less force is needed to cut through wires compared to previous products, as a result of optimised power transmission of the wire cutting forceps.

### EVERYTHING IN BALANCE

User-friendly weight and balance for smoother handling of the instrument.

# AESCULAP® SQ.line®

BASIC ORTHOPAEDIC INSTRUMENTS

## EASY REPROCESSING

### ➤ EASIER VISUAL INSPECTION

>50% reduction in difficult-to-inspect areas means visual inspection is faster and easier.\*

### ➤ REPAIR MADE EASY

Interchangeable jaws open up more possibilities for repair, which could reduce the number of repair replacement procurements, and could therefore also reduce the costs.

### ➤ SAVE TIME

Manual pre-cleaning steps can be eliminated with fully machine-cleanable instruments, resulting in time savings up to 12 minutes in handling time.

### ➤ BE SAFE

The limit of protein residues is reached at an earlier stage during cleaning and disinfection compared to current instrument designs. Probability of reprocessing rework is reduced.



\* A SQ.line® bone rongeur was compared with the previous product.



➤ **100% STAINLESS STEEL**

All instruments are made entirely from stainless steel. Without critical interfaces to other materials they are less vulnerable and easier to clean.





# SO\_line

## CONTENT

Mallets	10-12
Osteotomes	13-14, 23
Gouges	15-16, 19
Chisels	17
"Swan Neck" Chisel, Extraction Instrument for Protheses Stems	18
Chisels for Cement Removal	20-21
Cement Extractors	22
Bone Rongeurs	24-27
Bone Cutting Forceps	28
Curettes	29-31
Raspatories	32-34
Luxation Lever	35
Bone Hook, Drill	36
Ball Spikes	37
Wire Guides	38
Extraction Pliers	39
Wire Cutters	40
Tampers	41
Retractor, Retractor Blades	42
Numerical Index	43



■ Weight refers to the head weight of the respective mallet



**FL046211**  
Spare disc,  
diam. 30 mm  
metal convex



**FL046212**  
Spare disc,  
diam. 30 mm  
plastic convex



**FL046213**  
Spare disc,  
diam. 30 mm  
metal flat



**FL046214**  
Spare disc,  
diam. 30 mm  
plastic flat



**FL046NR** 330 g  
complete with:  
FL046211 Spare disc metal convex  
FL046212 Spare disc plastic convex  
FL062206 Wrench  
235 mm, 9 1/4"



**FL057NR** 380 g  
240 mm, 9 1/2"



**FL066NR** 580 g  
245 mm, 9 5/8"

▪ Weight refers to the head weight of the respective mallet



1/2

**FL062211**

Spare disc, diam. 35 mm  
metal convex



1/2

**FL062212**

Spare disc, diam. 35 mm  
plastic convex



1/2

**FL062213**

Spare disc, diam. 35 mm  
metal flat



1/2

**FL062214**

Spare disc, diam. 35 mm  
plastic w



530 g

Diam.  
35 mm

FL062NR  
CE

AESCLAP®

1/2

WAGNER

**FL062NR** 530 g

complete with:  
FL062211 Spare disc metal convex  
FL062212 Spare disc plastic convex  
FL062206 Wrench  
240 mm, 9 1/2"



zu FL062NR  
FL062R

AESCLAP®  
WAGNER

zu FL06NR

1/2

**FL062206**

Wrench  
for FL046NR and FL062NR  
for changing the spare  
discs



780 g

Diam.  
43 mm

FL069NR  
CE

AESCLAP®

1/2

**FL069NR** 780 g

245 mm, 9 5/8"

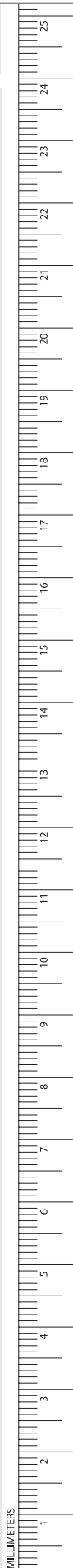

MILLIMETERS



- Weight refers to the head weight of the respective mallet

**INFO Box**

Mallet with slot KH113NR among other applicable with  
cement extractors

ND079R-ND081R, ND089R.....22

cement extractor hooks

ND082R-ND084R .....22



Slot width 6.5 mm

680 g

KH113NR  
CE

AESCULAP®

1/2

**KH113NR** 680 g  
Mallet with slot  
280 mm, 11"



Diam.  
38 mm

660 g

MB631NR  
CE

AESCULAP®

1/2

**MB631NR** 660 g  
225 mm, 8 7/8"





LEXER

Art. No.	Width
FL400NR	4 mm
FL401NR	6 mm
FL402NR	8 mm
FL403NR	10 mm
FL405NR	15 mm
FL406NR	20 mm
FL407NR	25 mm
FL408NR	30 mm

240 mm, 9 1/2"



LEXER

Art. No.	Width
FL820NR	4 mm
FL821NR	6 mm
FL822NR	8 mm
FL823NR	10 mm
FL825NR	15 mm
FL826NR	20 mm
FL827NR	25 mm
FL828NR	30 mm

300 mm, 11 3/4"



INFO Box

Osteotomes  
FL920NR-FL927NR  
to be used with cross bar  
ND078R .....21

LEXER

Art. No.	Width
FL920NR	4 mm
FL922NR	8 mm
FL925NR	15 mm
FL927NR	25 mm

400 mm, 15 3/4"

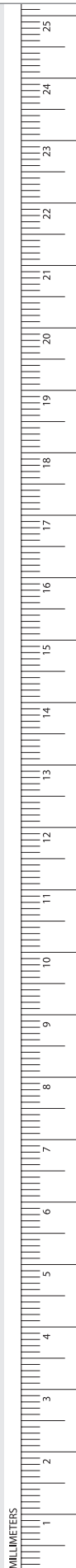

MILLIMETERS



**LEXER**  
**ND108NR**  
 angled  
 300 mm, 11 3/4"



**LEXER**  
**ND109NR**  
 angled  
 300 mm, 11 3/4"



LEXER

Art. No.	Width
FL410NR	4 mm
FL411NR	6 mm
FL412NR	8 mm
FL413NR	10 mm
FL415NR	15 mm
FL416NR	20 mm
FL417NR	25 mm
FL418NR	30 mm

240 mm, 9 1/2"

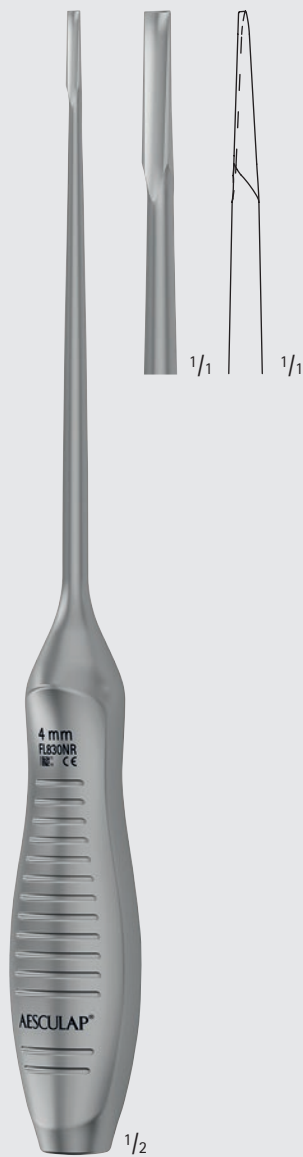

LEXER

Art. No.	Width
FL830NR	4 mm
FL831NR	6 mm
FL832NR	8 mm
FL833NR	10 mm
FL835NR	15 mm
FL836NR	20 mm
FL837NR	25 mm
FL838NR	30 mm

300 mm, 11 3/4"

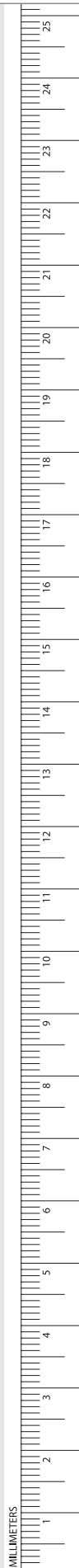



INFO Box

Gouges FL930NR-FL937NR  
to be used with cross bar  
ND078R .....21



LEXER

Art. No.	Width
FL930NR	4 mm
FL932NR	8 mm
FL935NR	15 mm
FL937NR	25 mm
400 mm, 15 3/4"	



Art. No.	Width
FL441NR	5 mm
FL443NR	10 mm
FL445NR	15 mm

Cancellous bone gouges, curved  
240 mm, 9 1/2"



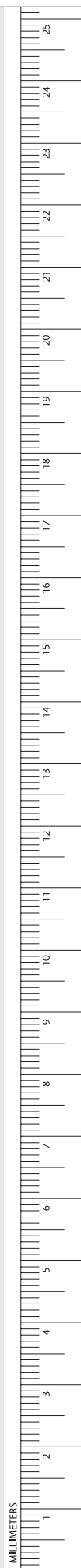
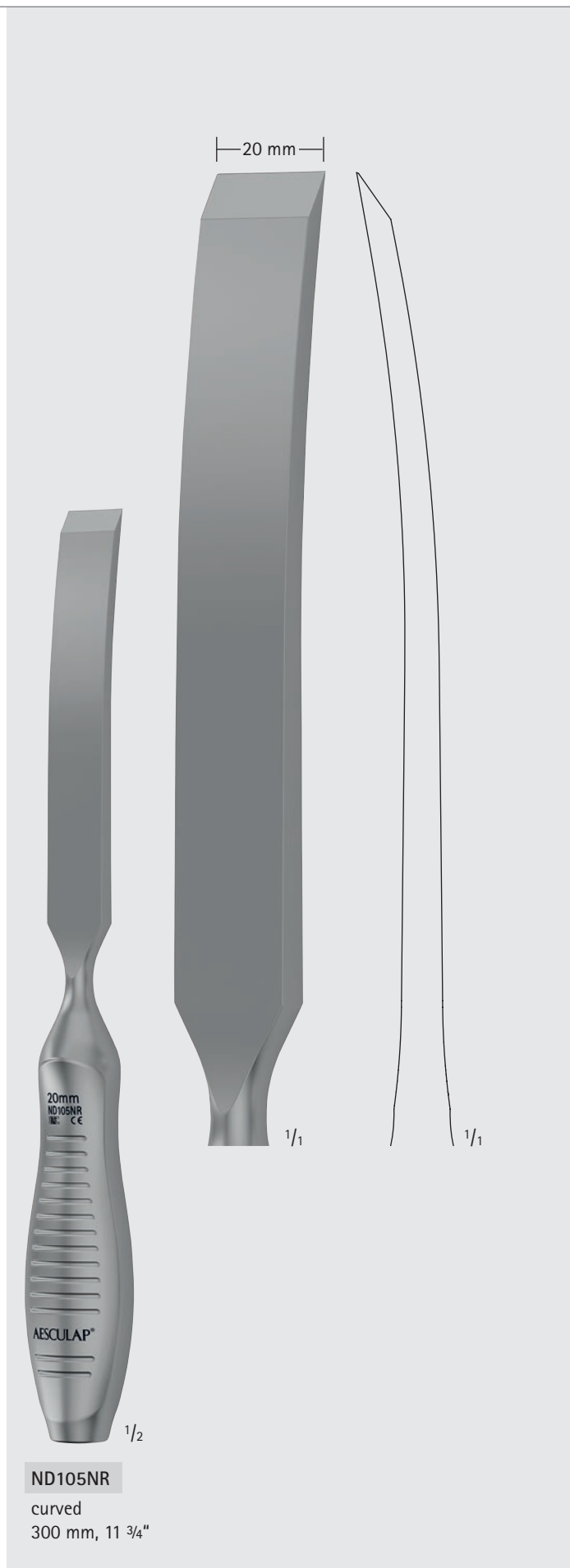
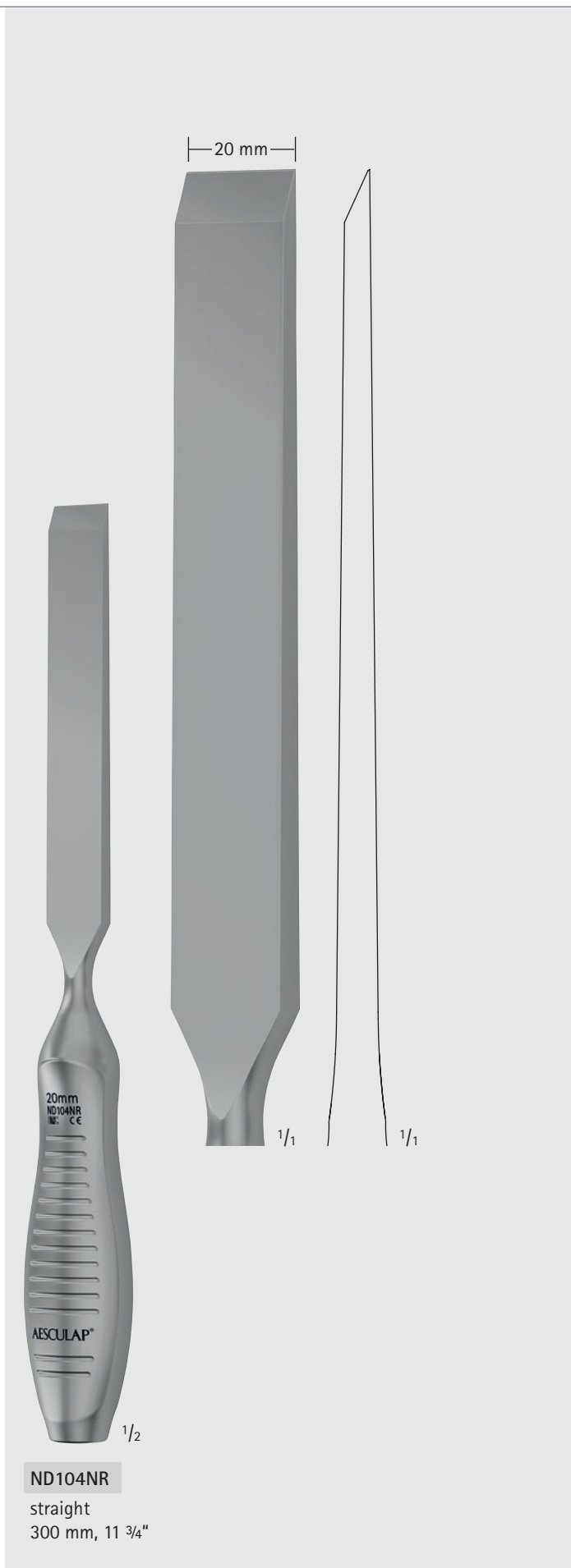

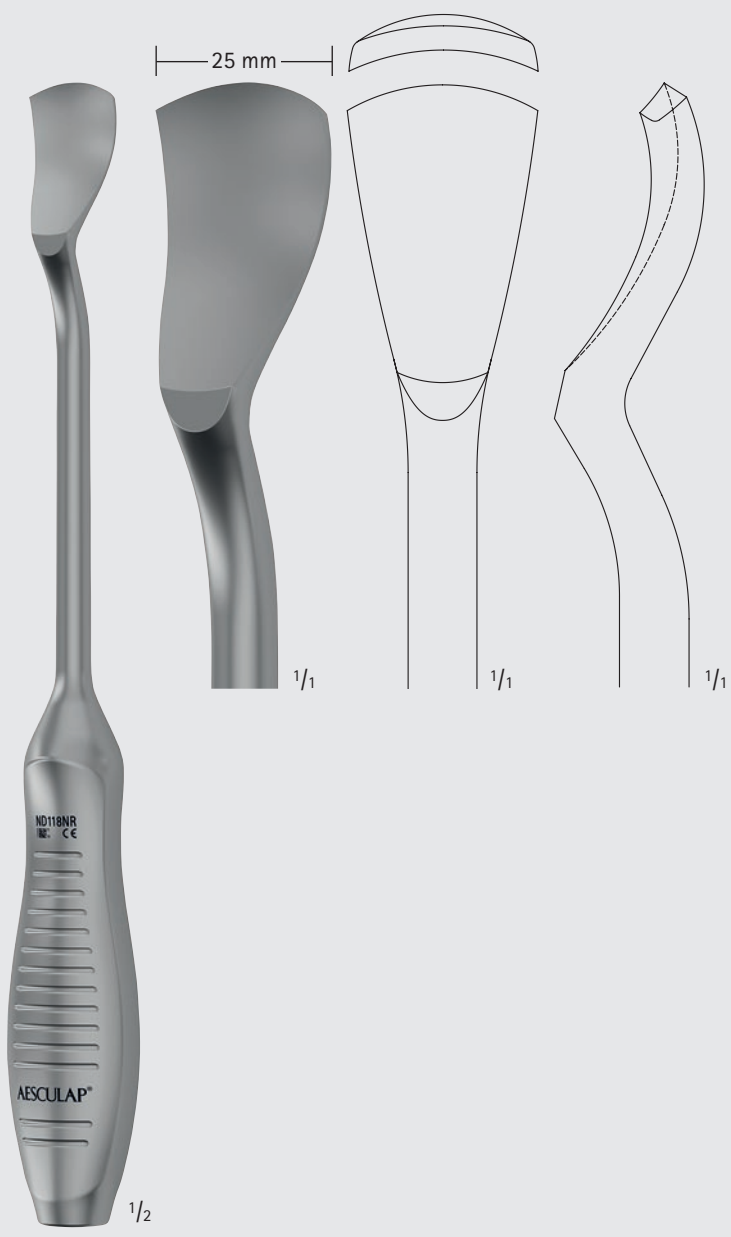

**ND118NR**  
"Swan neck" chisel  
300 mm, 11 3/4"

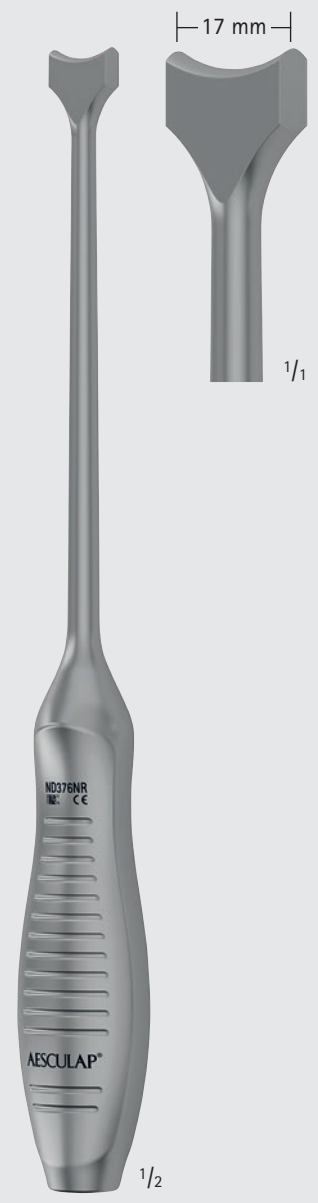

**ND376NR**  
Extraction instrument  
for prostheses stems  
300 mm, 11 3/4"



REPROCESSING INFORMATION  
for all AESCULAP® medical products. You will  
find the corresponding instructions for use for  
each article number on our website:  
[HTTP://BBRAUN.INFO/REPROCESSING](http://BBRAUN.INFO/REPROCESSING)

sq.line®  
GOUGES

INFO Box

Gouges ND091NR-ND098NR to be used  
with cross bar ND078R .....21

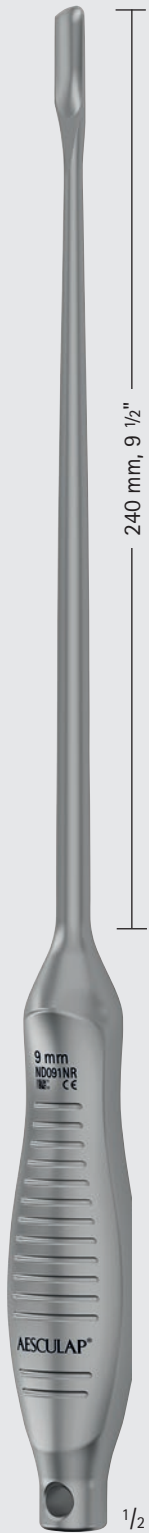

240 mm, 9 1/2"

WAGNER

ND091NR-ND098NR

400 mm, 15 3/4"

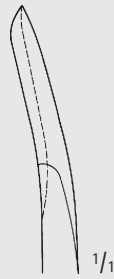

angled forward



angled backward



straight

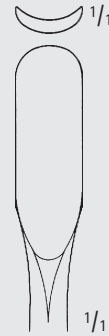

9 mm



ND092NR



ND093NR



ND091NR

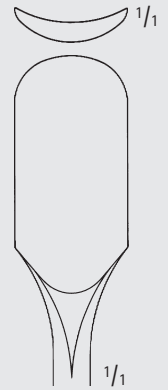

15 mm



ND097NR



ND098NR



ND096NR

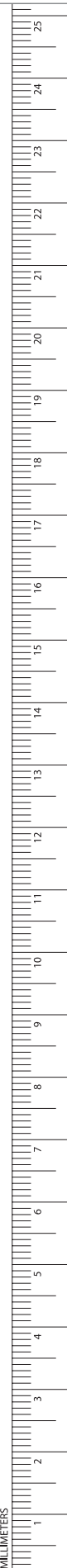



**INFO Box**  
Chisels ND066NR-ND068NR  
to be used with  
cross bar ND078R ..... 21

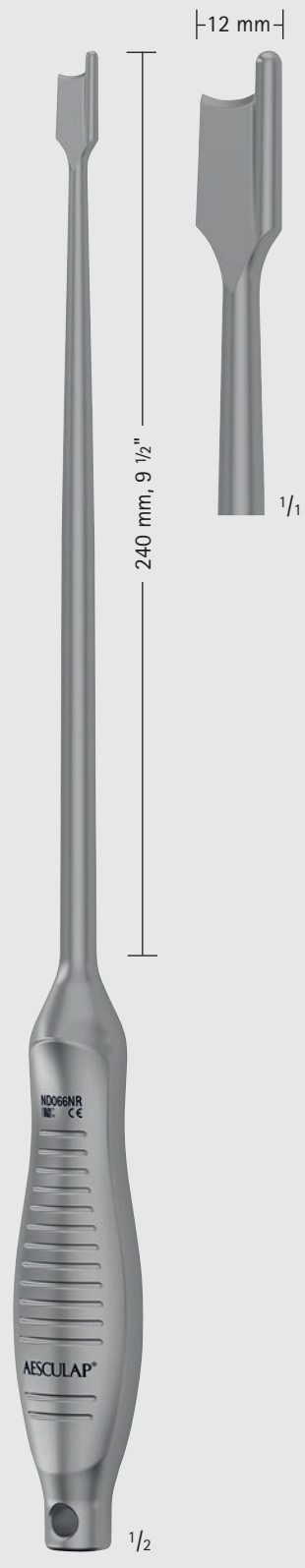

**ND066NR**  
straight,  
chamfered  
400 mm, 15 3/4"

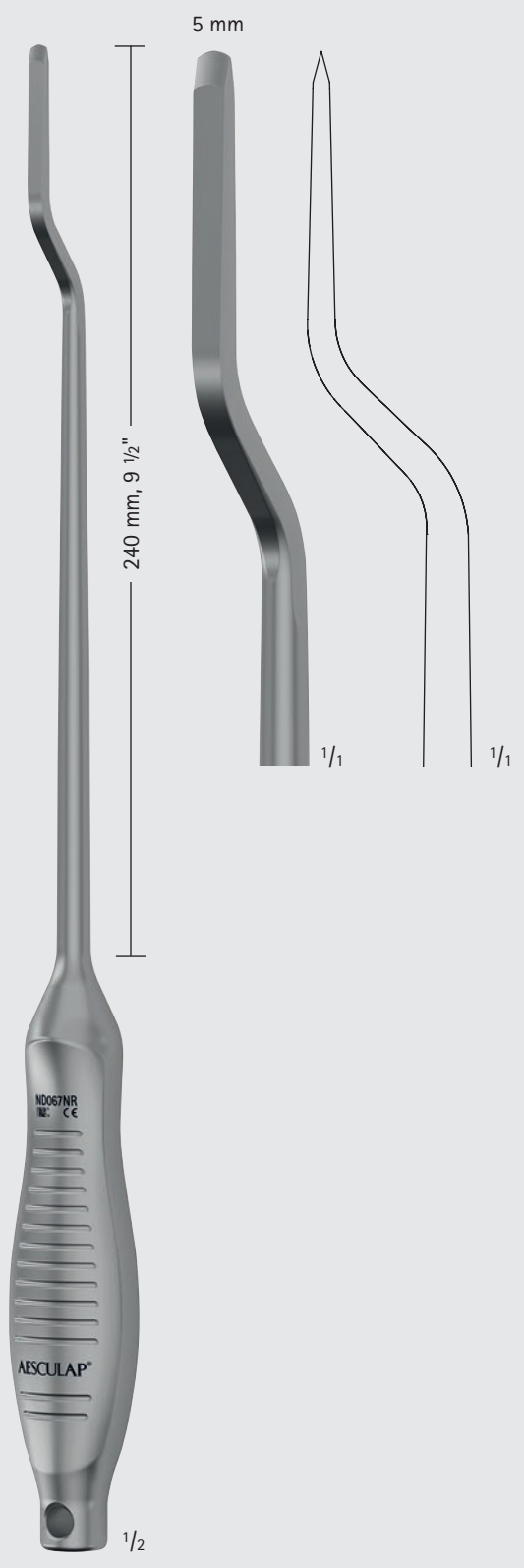

**ND067NR**  
bayonet-shaped  
400 mm, 15 3/4"

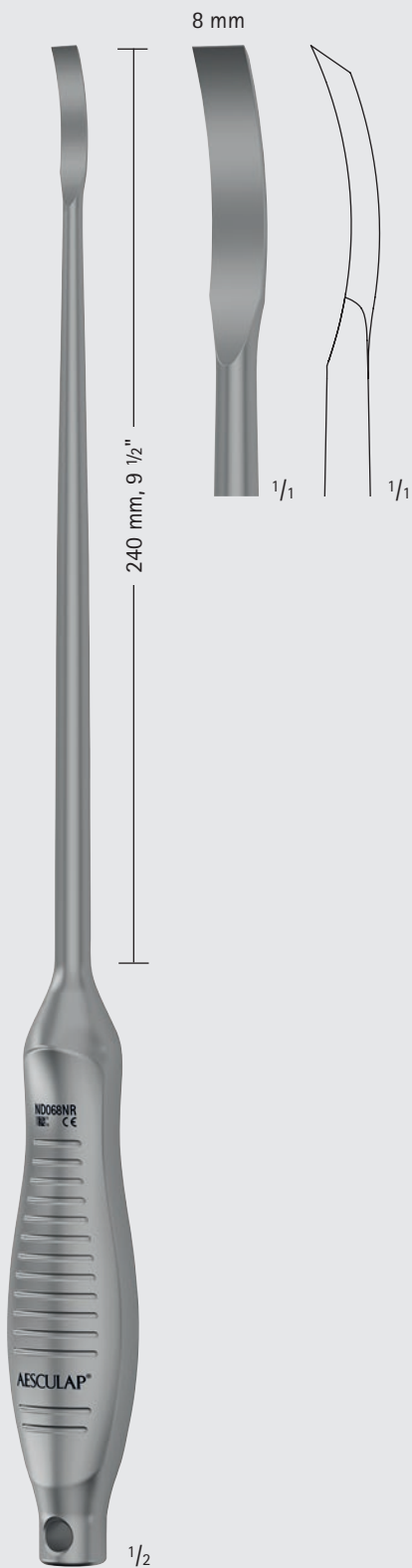

**ND068NR**

curved  
400 mm, 15 3/4"

INFO Box	
Cross bar ND078R for use with osteostomes:	
FL920NR-FL927NR .....	13
with chisels:	
FL930NR-FL937NR .....	16
with gouges:	
ND066NR-ND068NR .....	20, 21
ND091NR-ND098NR .....	19



**ND078R**

Cross bar  
110 mm, 4 1/4"

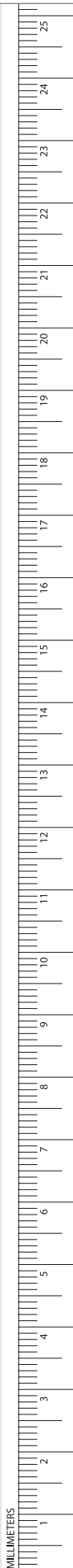

MILLIMETERS



**INFO Box**  
Mallet with slot  
KH113NR ..... 12  
among other applicable with  
cement extractors ND079R-ND081R,  
ND089R and  
cement extractor hooks ND082R-ND084R



Art. No.	Tip size diam.	Shaft diam.
ND079R	8 mm	6 mm
ND080R	10 mm	6 mm
ND081R	12 mm	6 mm
ND089R	14 mm	6 mm

Cement extractors with thread  
525 mm, 20 3/4"



Art. No.	Blade width	Shaft diam.
ND082R	6 mm	6 mm
ND083R	8 mm	6 mm
ND084R	10 mm	6 mm

Cement extractor hooks  
530 mm, 20 7/8"



LAMBOTTE

Art. No.	Width
FL650R	4 mm
FL663R	6 mm
FL651R	8 mm
FL652R	10 mm
FL653R	13 mm
FL654R	15 mm
FL655R	18 mm
FL656R	20 mm
FL658R	25 mm
FL659R	30 mm
FL660R	40 mm
FL662R	50 mm

straight  
240 mm, 9 1/2"



LAMBOTTE

Art. No.	Width
FL800R	4 mm
FL813R	6 mm
FL801R	8 mm
FL802R	10 mm
FL804R	15 mm
FL806R	20 mm
FL808R	25 mm
FL809R	30 mm
FL810R	40 mm
FL812R	50 mm

straight  
300 mm, 11 3/4"

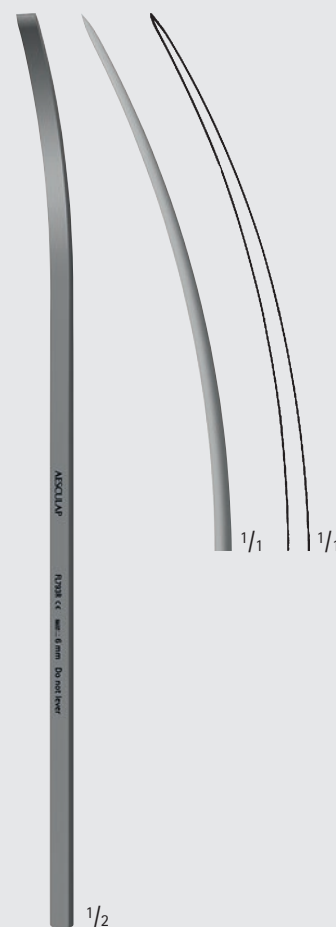

LAMBOTTE

Art. No.	Width
FL793R	6 mm
FL781R	8 mm
FL782R	10 mm
FL783R	15 mm
FL785R	20 mm
FL788R	25 mm
FL789R	30 mm
FL790R	40 mm

curved  
240 mm, 9 1/2"

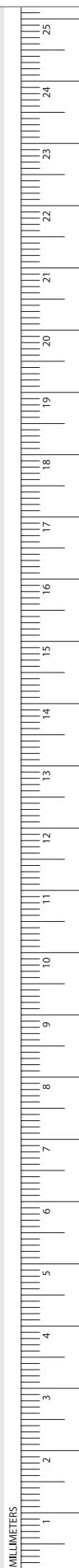

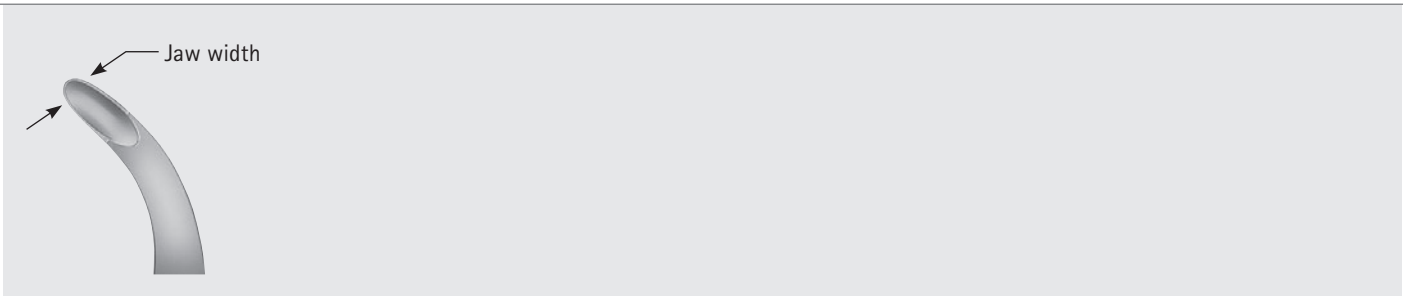

curved  
jaw width:  
3.8 mm

1/1

1/2

LUER  
**FO520NR**  
delicate pattern  
180 mm, 7"

curved  
jaw width:  
4.6 mm

1/1

1/2

LUER  
**FO515NR**  
medium pattern  
180 mm, 7"

curved  
jaw width:  
5.5 mm

1/1

1/2

LUER  
**FO518NR**  
strong pattern  
180 mm, 7"



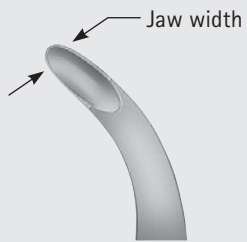

LUER  
**FO516NR**  
delicate pattern  
240 mm, 9 1/2"



LUER  
**FO517NR**  
medium pattern  
240 mm, 9 1/2"



LUER  
**FO521NR**  
strong pattern  
240 mm, 9 1/2"

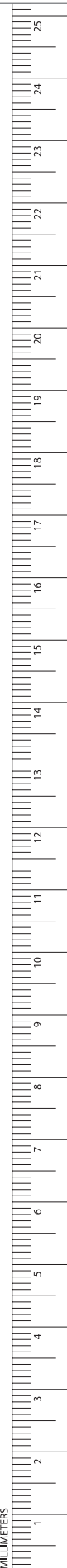

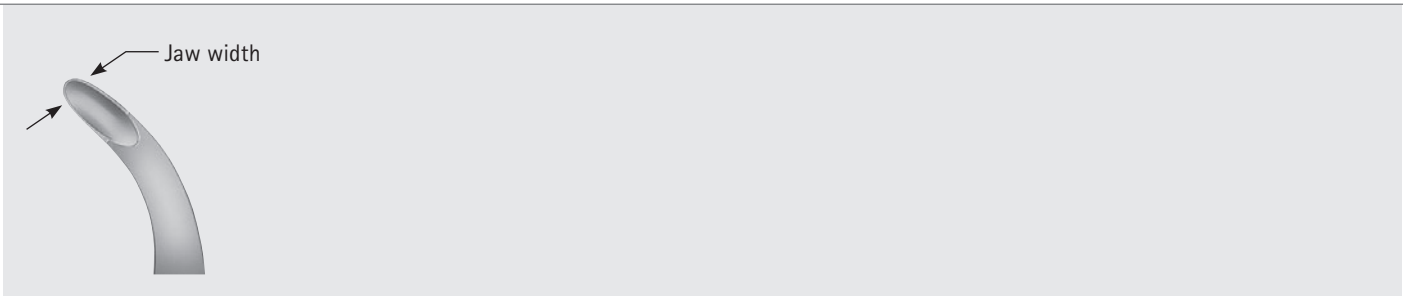

angled to side  
jaw width:  
6.8 mm

**LUER-STILLE**  
**FO530NR**  
very strong pattern  
240 mm, 9 1/2"

straight  
jaw width:  
8 mm

**LUER-STILLE**  
**FO532NR**  
very strong pattern  
240 mm, 9 1/2"

curved  
jaw width:  
8 mm

**LUER-STILLE**  
**FO534NR**  
very strong pattern  
240 mm, 9 1/2"

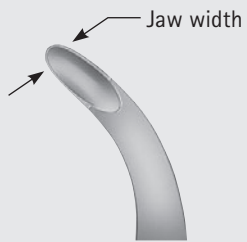

LUER-STILLE  
**FO550NR**  
extra strong pattern  
240 mm, 9 1/2"

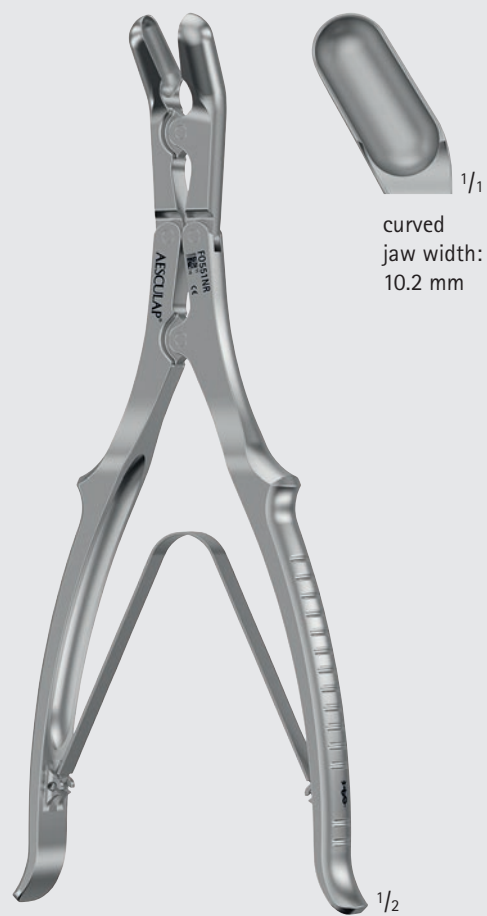

LUER-STILLE  
**FO551NR**  
extra strong pattern  
240 mm, 9 1/2"

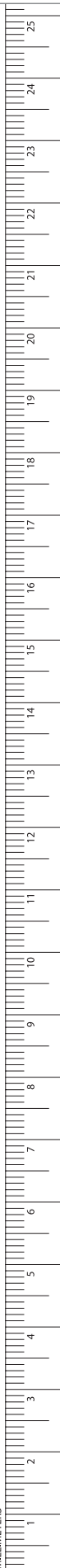

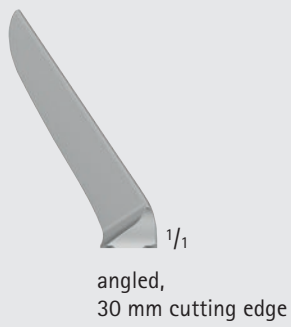

LISTON  
FO645NR  
240 mm, 9 1/2"



RUSKIN-LISTON  
FO641NR  
180 mm, 7"

2.8 mm



FK630NR

3.6 mm



FK631NR

4.4 mm



FK632NR

5.2 mm



FK633NR

6.8 mm



FK634NR

8.5 mm



FK635NR

10 mm



FK636NR

11.5 mm



FK637NR

13 mm



FK638NR

14.5 mm



FK639NR



VOLKMANN

FK630NR-FK639NR

180 mm, 7"

2.8 mm



FK640NR

3.6 mm



FK641NR

4.4 mm



FK642NR

5.2 mm



FK643NR

6.8 mm



FK644NR

8.5 mm



FK645NR

10 mm



FK646NR

11.5 mm



FK647NR

13 mm



FK648NR

14.5 mm



FK649NR



VOLKMANN

FK640NR-FK649NR

240 mm, 9 1/2"

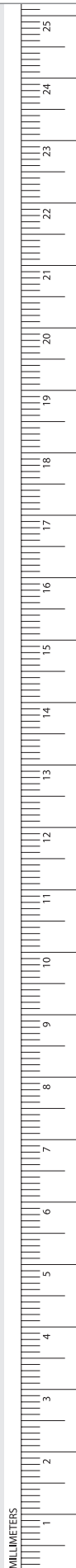





5.2 mm  
 1/1  
**FK743NR**

8.5 mm  
 1/1  
**FK745NR**

11.5 mm  
 1/1  
**FK747NR**

**VOLKMANN**  
**FK743NR-FK747NR**  
 300 mm, 11 3/4"

5.2 mm  
 1/1  
**FK753NR**

8.5 mm  
 1/1  
**FK755NR**

11.5 mm  
 1/1  
**FK757NR**

**VOLKMANN**  
**FK753NR-FK757NR**  
 400 mm, 15 3/4"

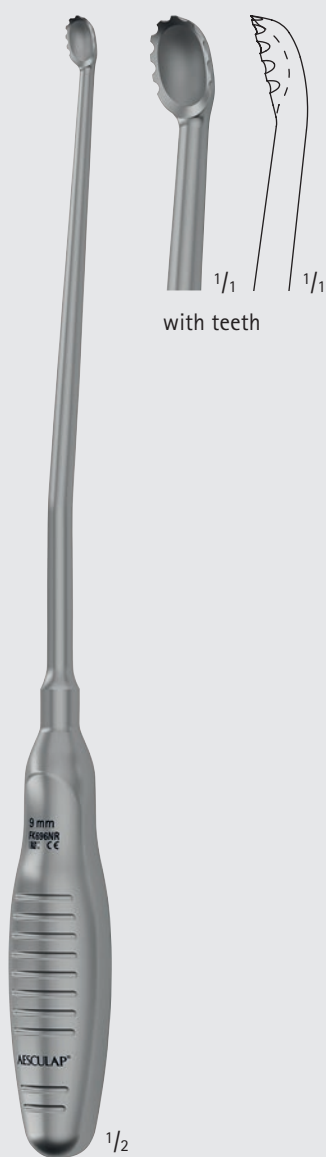

Art. No.	Width
FK696NR	9 mm
FK698NR	15 mm
300 mm, 11 3/4"	



ND019NR  
300 mm, 11 3/4"

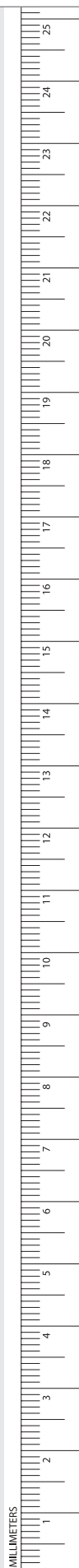

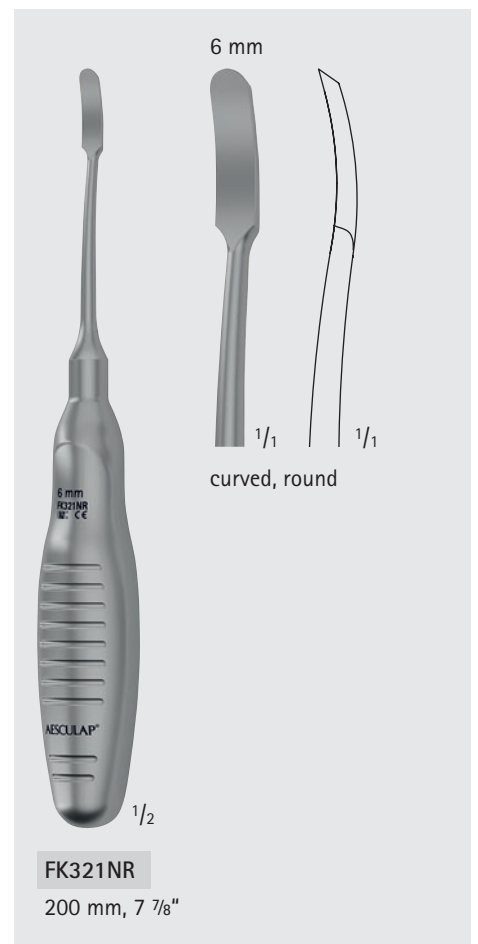
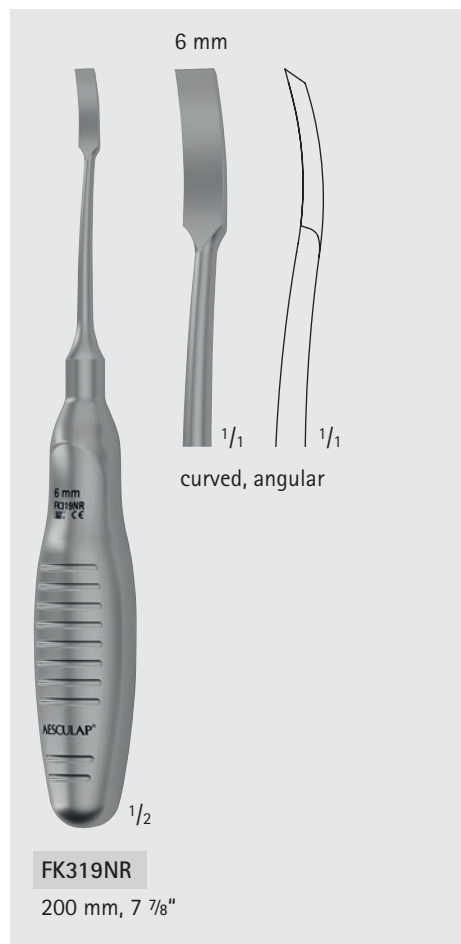
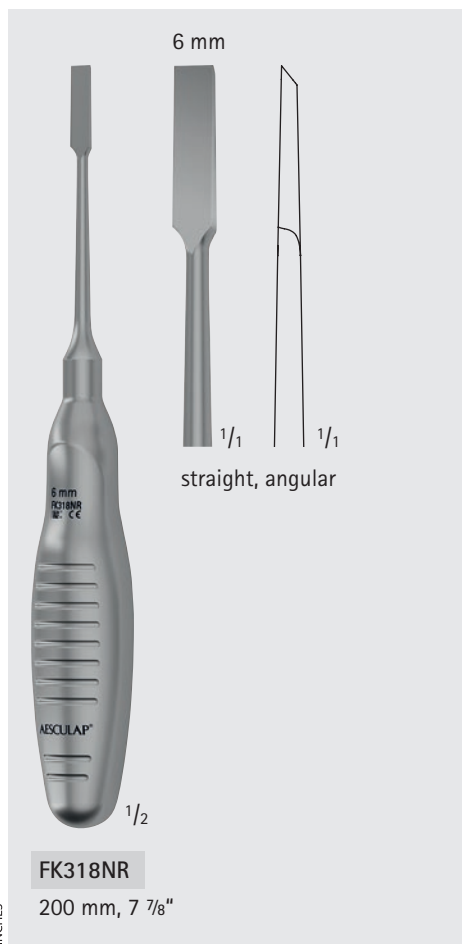
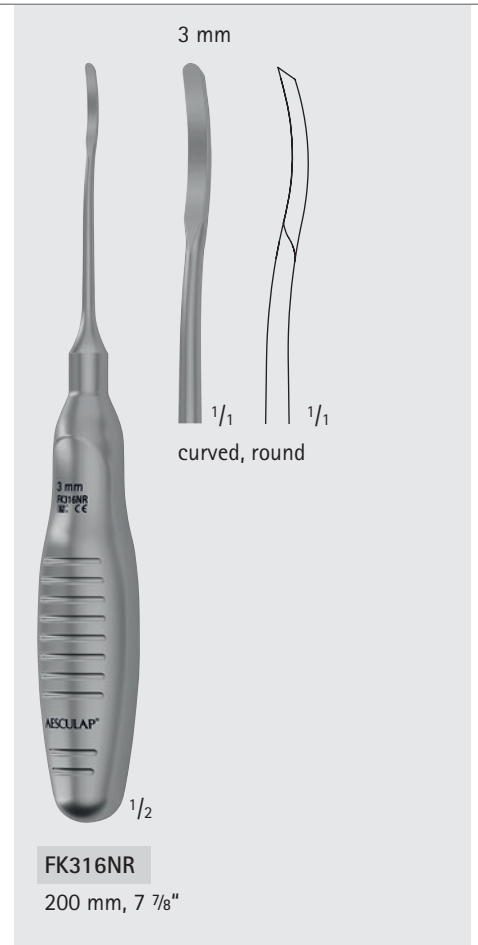
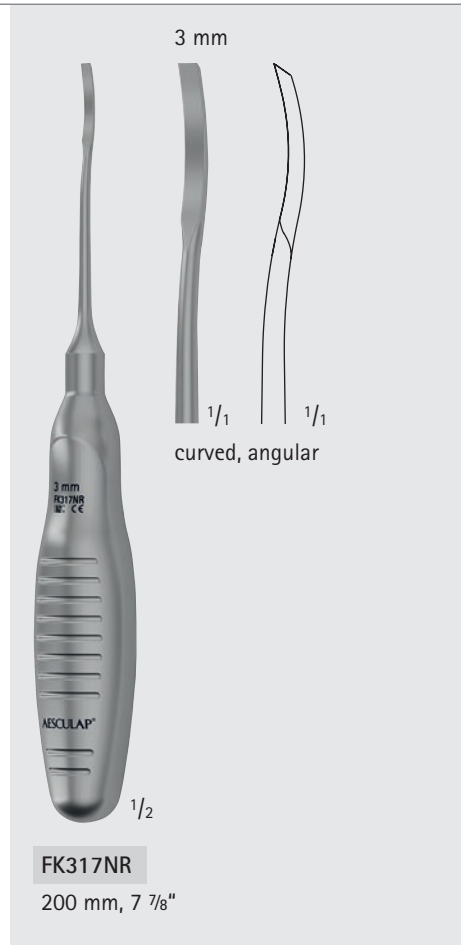
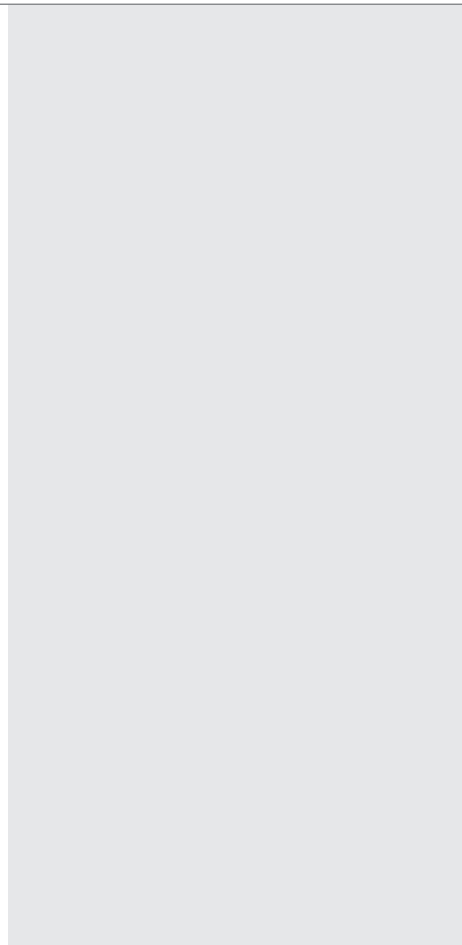



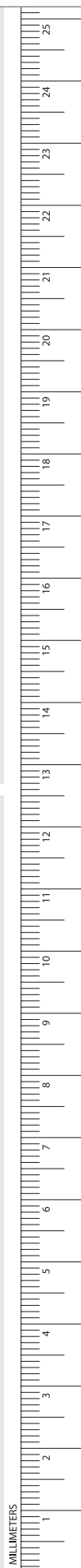
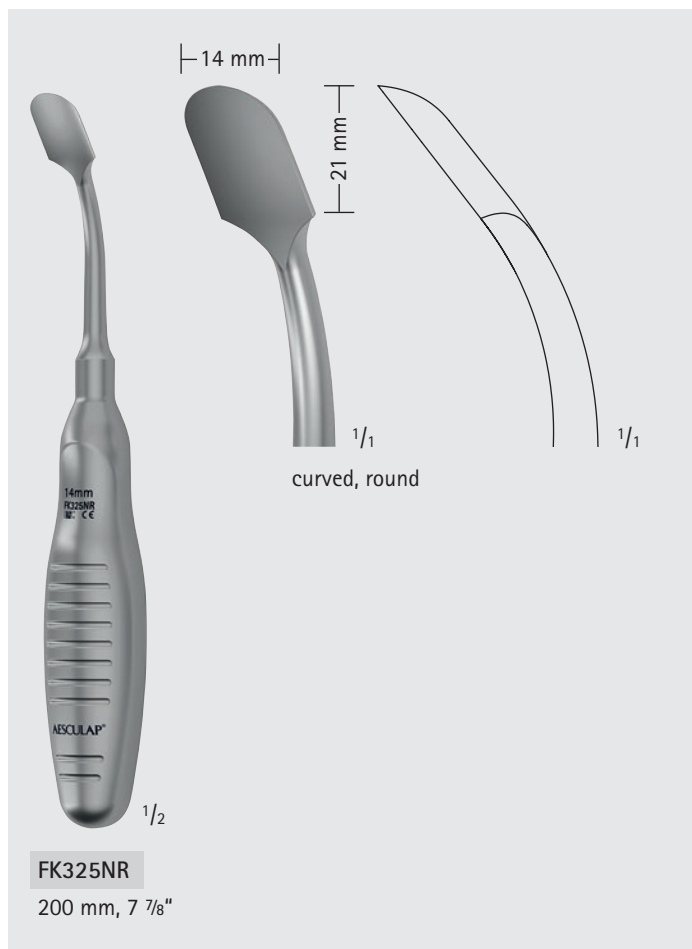
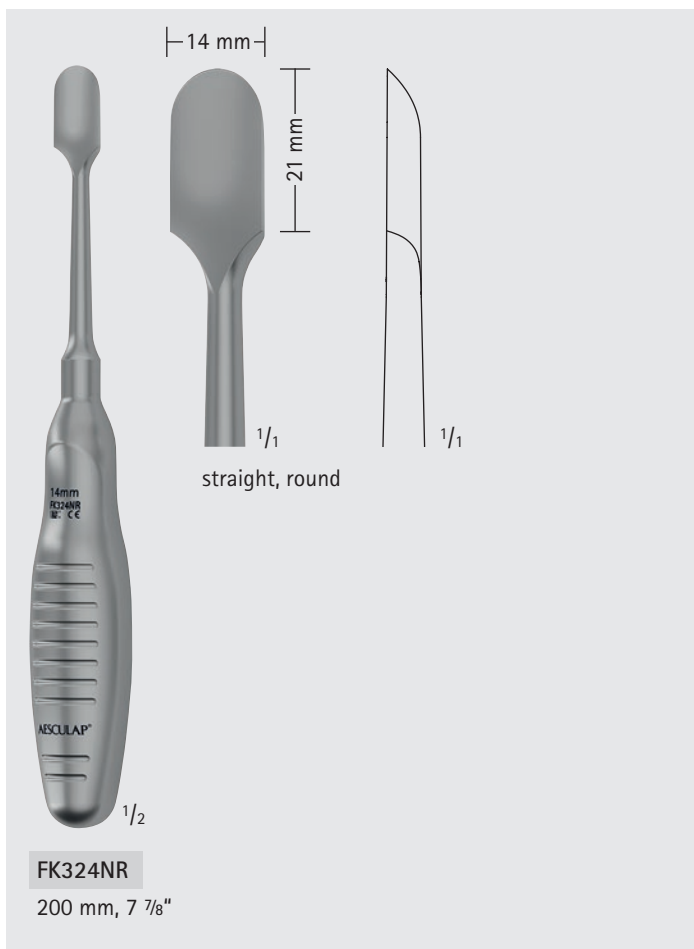
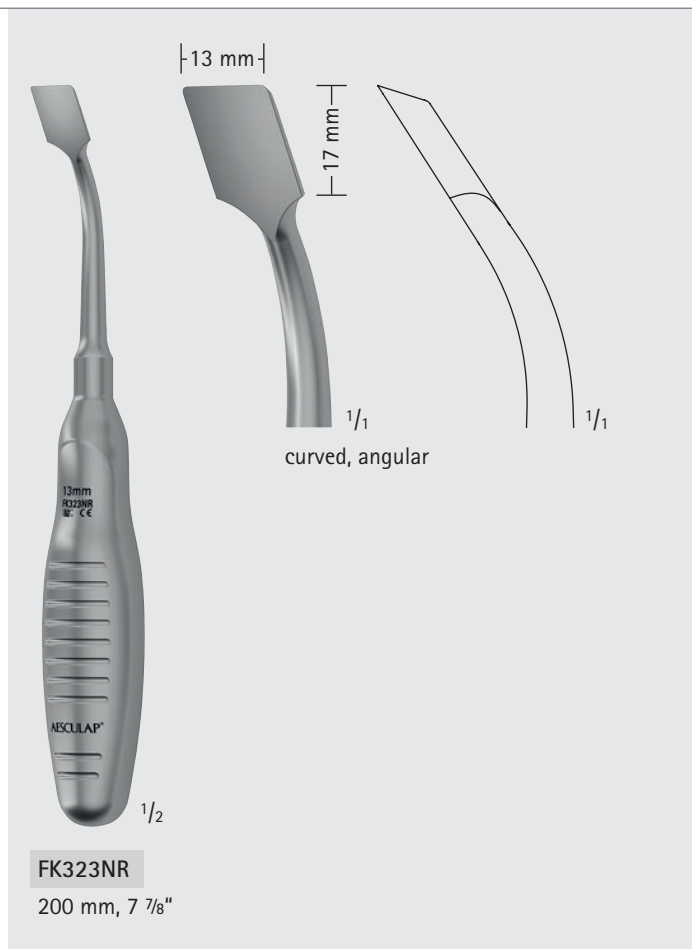
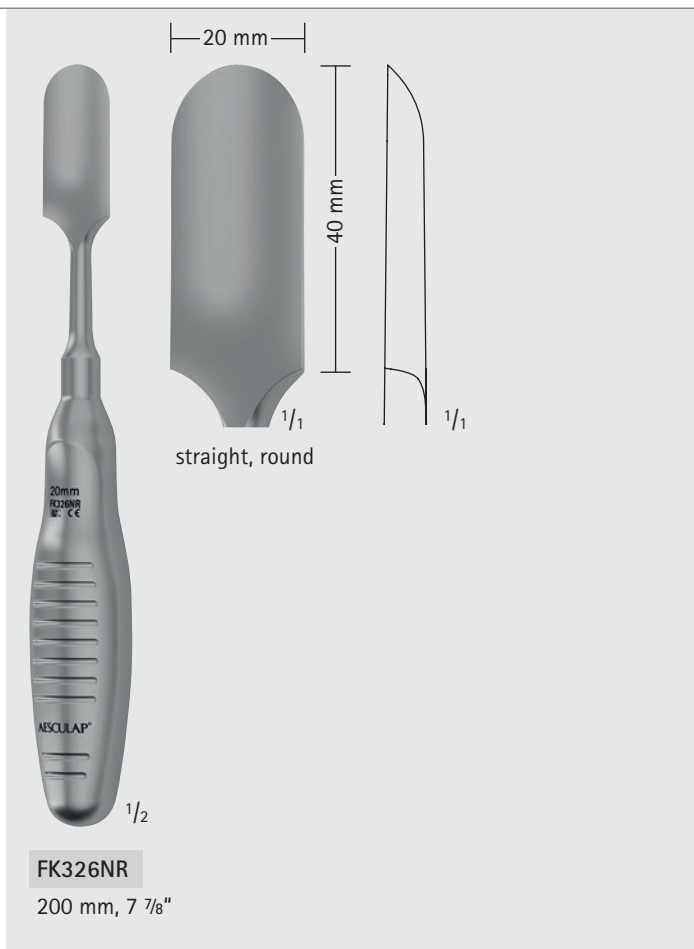

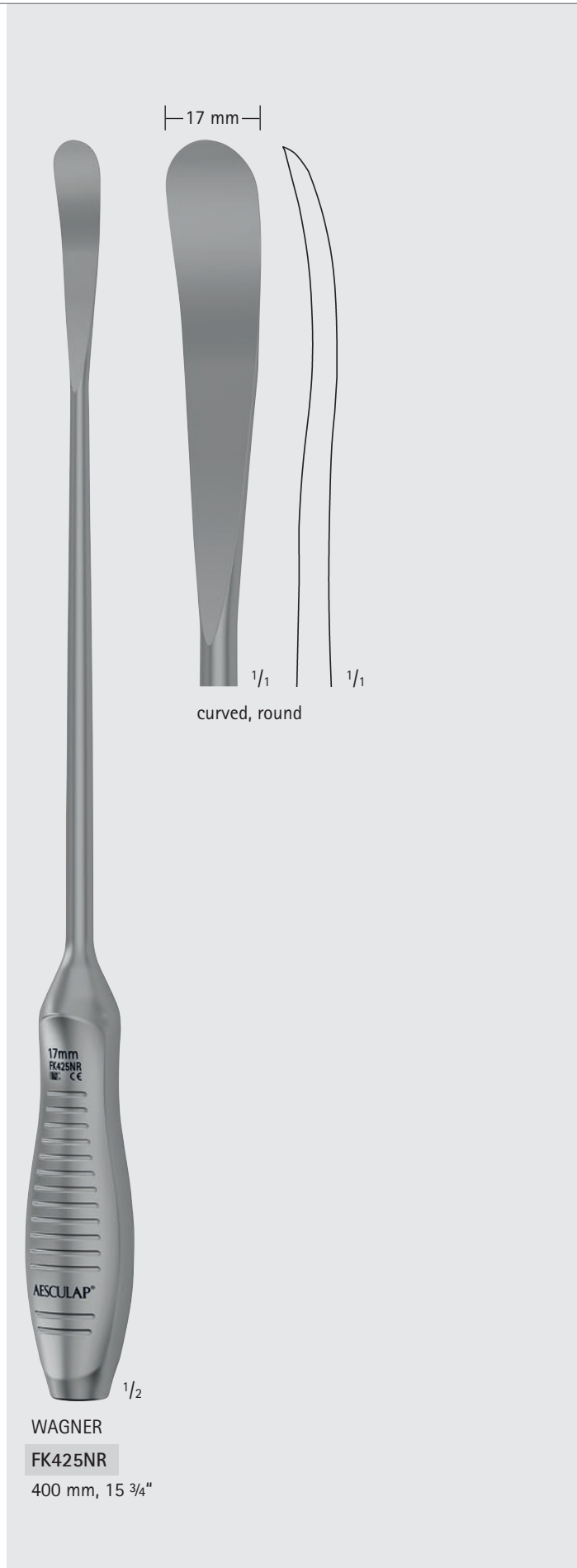
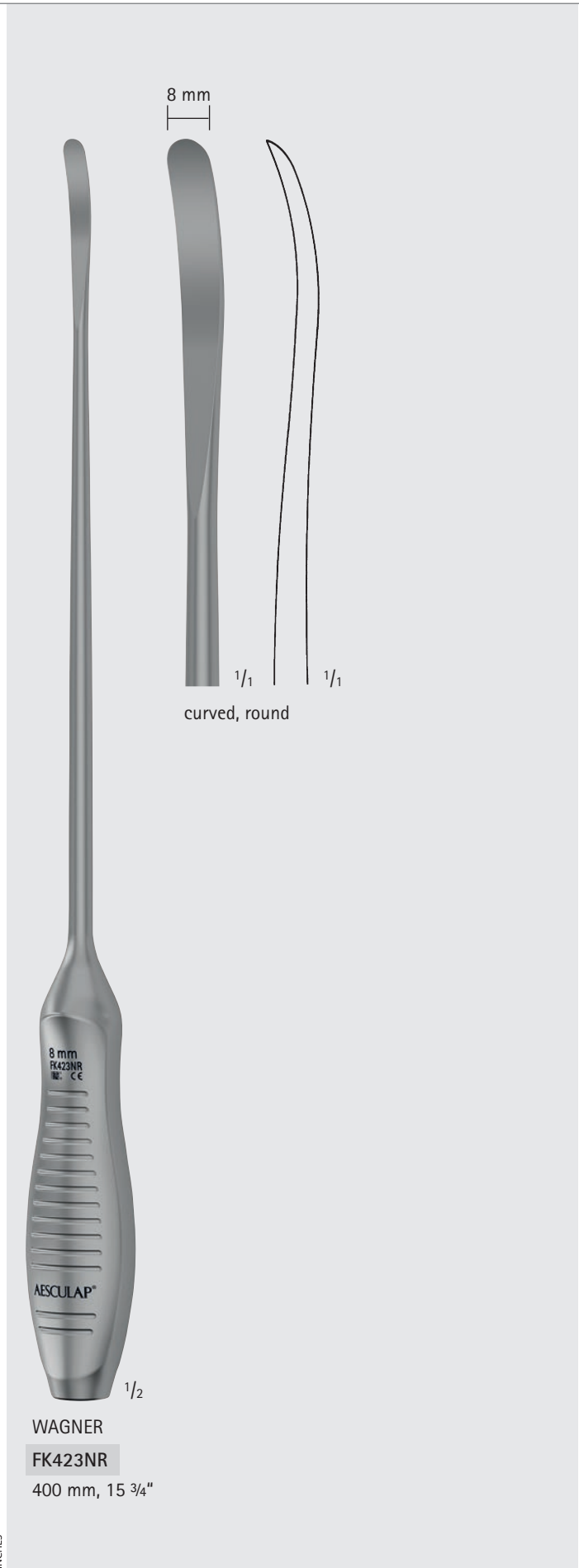

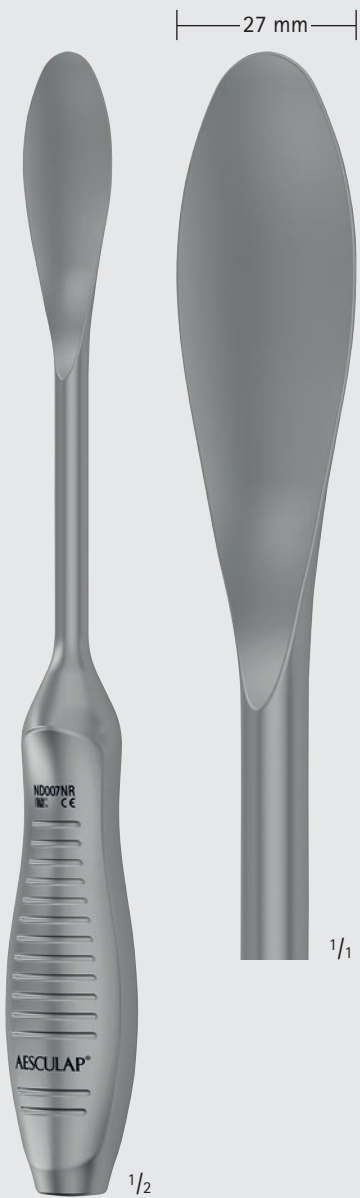

**ND007NR**  
for dislocating the  
femoral head  
300 mm, 11 3/4"

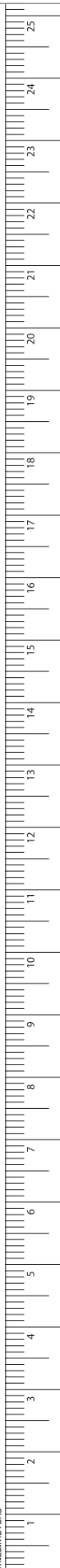

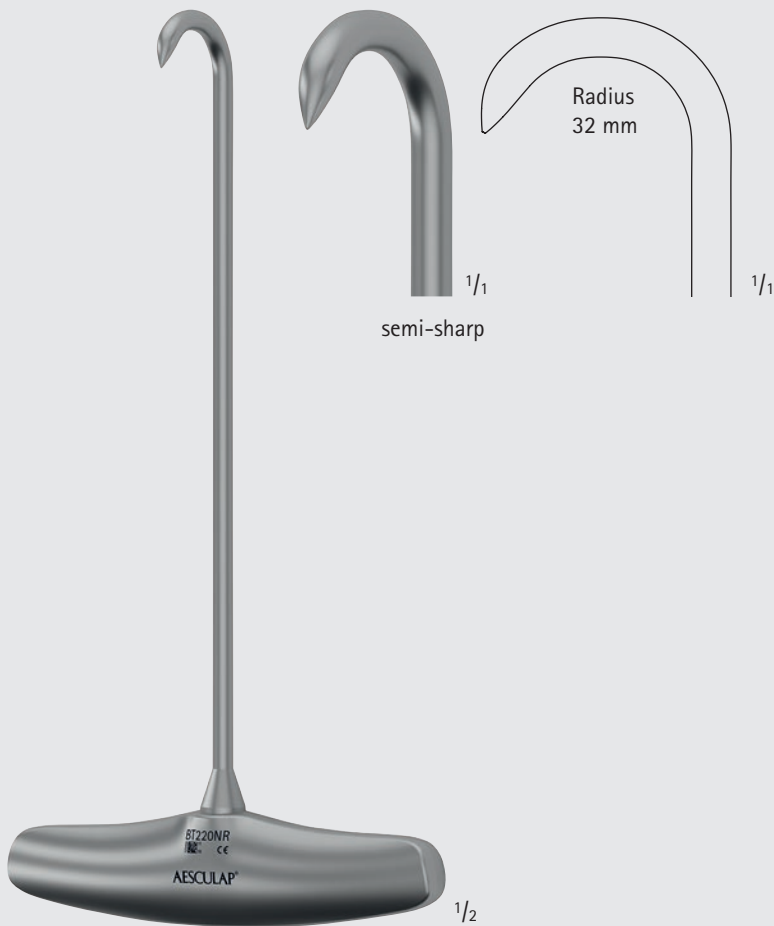

**BT220NR**  
Bone hook with T-handle  
240 mm, 9 1/2"

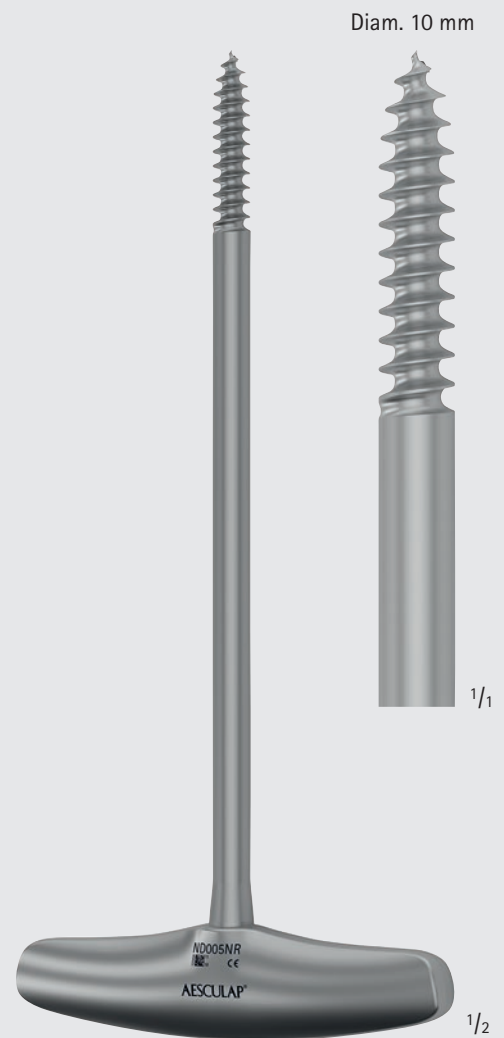

**ND005NR**  
Drill with T-handle  
for femoral head extraction  
260 mm, 10 1/4"



**FO102NR**  
200 mm, 7 7/8"



**FO103NR**  
240 mm, 9 1/2"

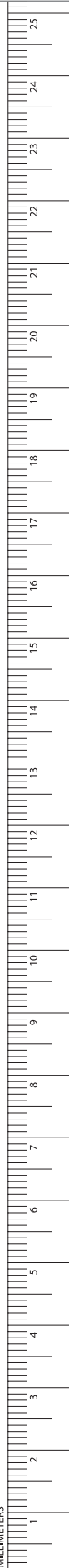

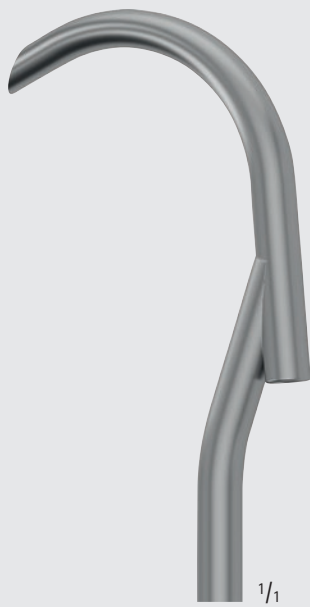
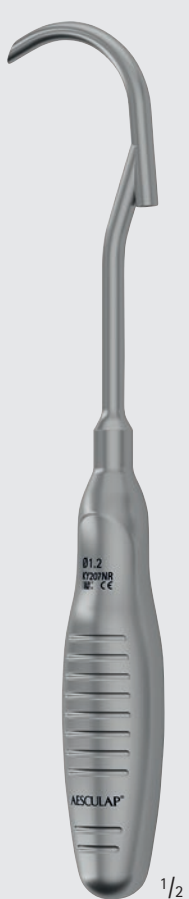
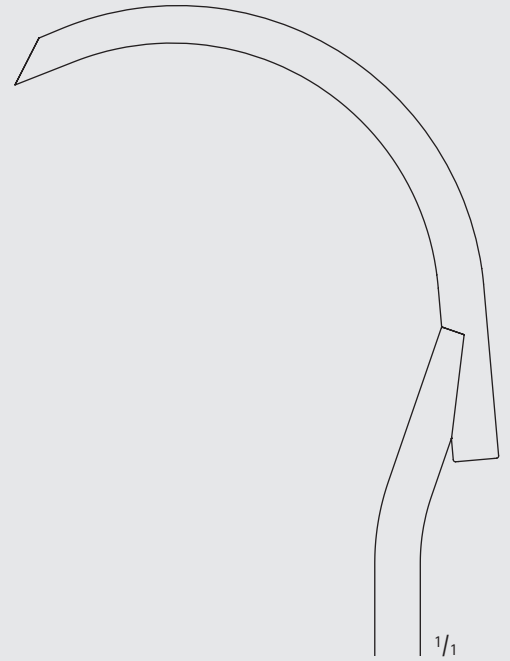
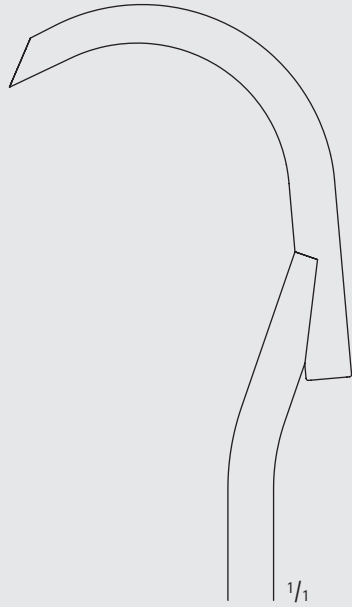

small, curved  
for wire  
diam. 1.2 mm

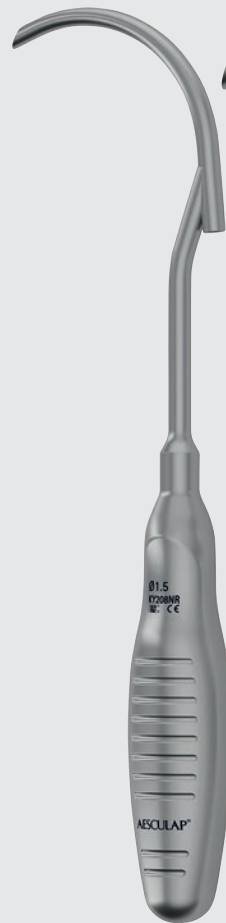

large, curved  
for wire  
diam. 1.5 mm

**KY207NR**  
230 mm, 9"

**KY208NR**  
240 mm, 9 1/2"



**LX181NR**  
Round pliers  
180 mm, 7"

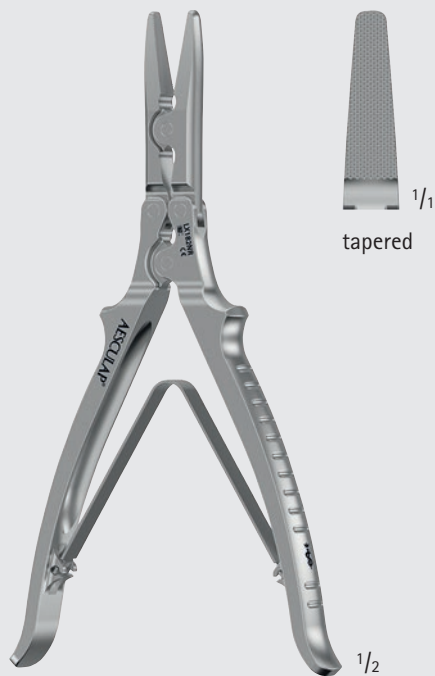

**LX182NR**  
Extraction pliers  
180 mm, 7"

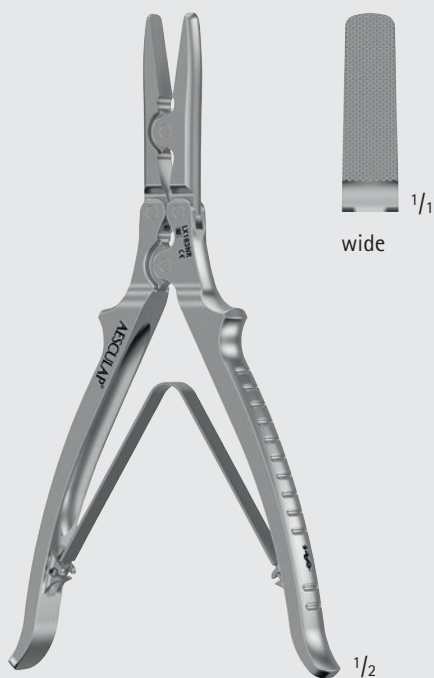

**LX183NR**  
Extraction pliers  
180 mm, 7"

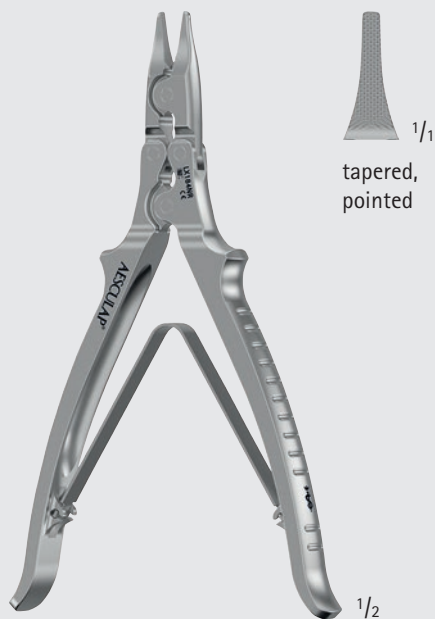

**LX184NR**  
Extraction pliers  
160 mm, 6 1/4"

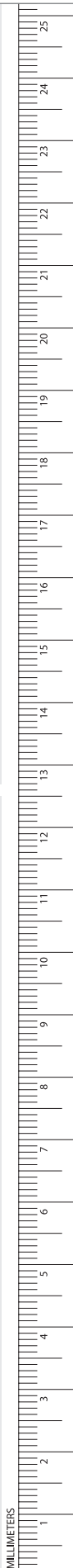



- specially hardened cutting edges



**LX159NR**

for hard wire with diam. maximum up to 1.5 mm  
 180 mm, 7"

- specially hardened cutting edges

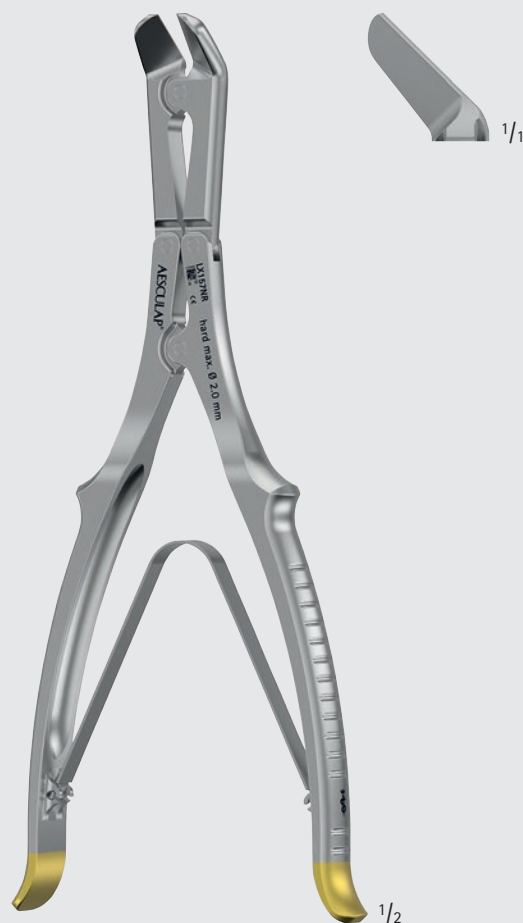

**LX157NR**

for hard wire with diam. maximum up to 2.0 mm  
 240 mm, 9 1/2"





1/1

**FL083NR**

Diam. 5 mm



1/1

**FL084NR**

Diam. 8 mm

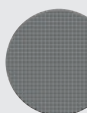

1/1

**FL086NR**

Diam. 14 mm

**FL083NR-FL086NR**

round, cross serrated  
300 mm, 11 3/4"



1/1



1/1

**ND584NR**

9 x 3.5 mm



1/1

**ND585NR**

10 x 6 mm



1/1

**ND586NR**

17 x 7 mm



1/1

**ND588NR**

10 x 10 mm

**ND584NR-ND586NR, ND588NR**

straight



1/1

**ND587NR**

10 x 6 mm

**ND587NR**

curved

**ND584NR-ND588NR**

rectangular, cross serrated  
300 mm, 11 3/4"

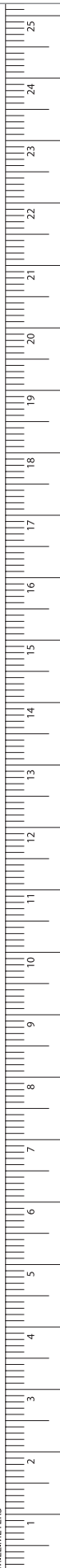

MILLIMETERS



CHARNLEY

**MB191R**

Retractor basis set, consisting of:

**MG697R** Frame, 300 x 240 mm

**MG081R** Weight, 1.740 g, with chain

**MB156R** Blade, small, 60 mm, 37 x 25 mm

**MB157R** Blade, large, 174 mm, 42 x 25 mm

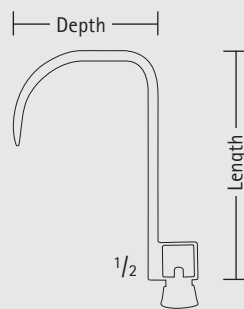

CHARNLEY

Art. No.	Depth x Width	Blade length
MG699R	25 x 25 mm	60 mm
MB156R	37 x 25 mm	60 mm
MG698R	51 x 25 mm	60 mm
MG565R	57 x 25 mm	60 mm
MG566R	64 x 25 mm	60 mm
MB177R	76 x 25 mm	60 mm
MG567R	102 x 25 mm	60 mm
MG700R	114 x 25 mm	60 mm
MB192R	127 x 25 mm	60 mm

Retractor blades, small

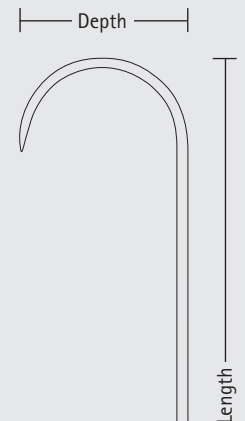

CHARNLEY

Art. No.	Depth x Width	Blade length
MG701R	25 x 25 mm	174 mm
MB157R	42 x 25 mm	174 mm
MG702R	51 x 25 mm	198 mm
MG568R	57 x 25 mm	192 mm
MG569R	65 x 25 mm	183 mm
MB178R	76 x 25 mm	174 mm
MG703R	102 x 25 mm	174 mm
MG570R	114 x 25 mm	174 mm
MB193R	127 x 25 mm	174 mm

Retractor blades, large

Art. No.	Page	Art. No.	Page	Art. No.	Page	Art. No.	Page
BT220NR.....	36	FL083NR.....	41	FL825NR.....	13	MB631NR.....	12
		FL084NR.....	41	FL826NR.....	13		
FK316NR.....	32	FL086NR.....	41	FL827NR.....	13	MG081R.....	42
FK317NR.....	32	FL400NR.....	13	FL828NR.....	13	MG565R.....	42
FK318NR.....	32	FL401NR.....	13	FL830NR.....	15	MG566R.....	42
FK319NR.....	32	FL402NR.....	13	FL831NR.....	15	MG567R.....	42
FK321NR.....	32	FL403NR.....	13	FL832NR.....	15	MG568R.....	42
FK323NR.....	33	FL405NR.....	13	FL833NR.....	15	MG569R.....	42
FK324NR.....	33	FL406NR.....	13	FL835NR.....	15	MG570R.....	42
FK325NR.....	33	FL407NR.....	13	FL836NR.....	15	MG697R.....	42
FK326NR.....	33	FL408NR.....	13	FL837NR.....	15	MG698R.....	42
FK423NR.....	34	FL410NR.....	15	FL838NR.....	15	MG699R.....	42
FK425NR.....	34	FL411NR.....	15	FL920NR.....	13	MG700R.....	42
FK630NR.....	29	FL412NR.....	15	FL922NR.....	13	MG701R.....	42
FK631NR.....	29	FL413NR.....	15	FL925NR.....	13	MG702R.....	42
FK632NR.....	29	FL415NR.....	15	FL927NR.....	13	MG703R.....	42
FK633NR.....	29	FL416NR.....	15	FL930NR.....	16		
FK634NR.....	29	FL417NR.....	15	FL932NR.....	16	ND005NR.....	36
FK635NR.....	29	FL418NR.....	15	FL935NR.....	16	ND007NR.....	35
FK636NR.....	29	FL441NR.....	16	FL937NR.....	16	ND019NR.....	31
FK637NR.....	29	FL443NR.....	16			ND066NR.....	20
FK638NR.....	29	FL445NR.....	16	FO102NR.....	37	ND067NR.....	20
FK639NR.....	29	FL650R.....	23	FO103NR.....	37	ND068NR.....	21
FK640NR.....	29	FL651R.....	23	FO515NR.....	24	ND078R.....	21
FK641NR.....	29	FL652R.....	23	FO516NR.....	25	ND079R.....	22
FK642NR.....	29	FL653R.....	23	FO517NR.....	25	ND080R.....	22
FK643NR.....	29	FL654R.....	23	FO518NR.....	24	ND081R.....	22
FK644NR.....	29	FL655R.....	23	FO520NR.....	24	ND082R.....	22
FK645NR.....	29	FL656R.....	23	FO521NR.....	25	ND083R.....	22
FK646NR.....	29	FL658R.....	23	FO530NR.....	26	ND084R.....	22
FK647NR.....	29	FL659R.....	23	FO532NR.....	26	ND089R.....	22
FK648NR.....	29	FL660R.....	23	FO534NR.....	26	ND091NR.....	19
FK649NR.....	29	FL662R.....	23	FO550NR.....	27	ND092NR.....	19
FK696NR.....	31	FL663R.....	23	FO551NR.....	27	ND093NR.....	19
FK698NR.....	31	FL781R.....	23	FO641NR.....	28	ND096NR.....	19
FK743NR.....	30	FL782R.....	23	FO645NR.....	28	ND097NR.....	19
FK745NR.....	30	FL783R.....	23			ND098NR.....	19
FK747NR.....	30	FL785R.....	23	KH113NR.....	12	ND104NR.....	17
FK753NR.....	30	FL788R.....	23			ND105NR.....	17
FK755NR.....	30	FL789R.....	23	KY207NR.....	38	ND108NR.....	14
FK757NR.....	30	FL790R.....	23	KY208NR.....	38	ND109NR.....	14
		FL793R.....	23			ND118NR.....	18
FL046NR.....	10	FL800R.....	23	LX157NR.....	40	ND376NR.....	18
FL046211.....	10	FL801R.....	23	LX159NR.....	40	ND584NR.....	41
FL046212.....	10	FL802R.....	23	LX181NR.....	39	ND585NR.....	41
FL046213.....	10	FL804R.....	23	LX182NR.....	39	ND586NR.....	41
FL046214.....	10	FL806R.....	23	LX183NR.....	39	ND587NR.....	41
FL057NR.....	10	FL808R.....	23	LX184NR.....	39	ND588NR.....	41
FL062NR.....	11	FL809R.....	23				
FL062206.....	11	FL810R.....	23	MB156R.....	42		
FL062211.....	11	FL812R.....	23	MB157R.....	42		
FL062212.....	11	FL813R.....	23	MB177R.....	42		
FL062213.....	11	FL820NR.....	13	MB178R.....	42		
FL062214.....	11	FL821NR.....	13	MB191R.....	42		
FL066NR.....	10	FL822NR.....	13	MB192R.....	42		
FL069NR.....	11	FL823NR.....	13	MB193R.....	42		

# AESFULAP<sup>®</sup> – a B. Braun brand

Aesculap AG | Am Aesculap-Platz | 78532 Tuttlingen | Germany  
Phone +49 7461 95-0 | Fax +49 7461 95-2600 | [www.aesculap.com](http://www.aesculap.com)

The main product trademark "AESFULAP" and the product trademark "SQ.line" are registered trademarks of Aesculap AG. Subject to technical changes. All rights reserved. This brochure may only be used for the exclusive purpose of obtaining information about our products. Reproduction in any form partial or otherwise is not permitted.