

Inhoud

3-wegkranen en kranenblokken	
Discofix® C	4
Verleng- en spiraallijnen	
Standaard verlenglijn	5
Perfusor® verlenglijn	6
Spiraallijn	7
Accessoires	
Filters	8
Afsluitdoppen, back-check valves en adapters	9
Caresite®	10
Safeflow	11
Sputen en naalden	
Overzicht spuit	14
Overzicht naalden	15
Productassortiment	16 - 31

Discofix® C

3-wegkraan



Gemaakt van hoogwaardig materiaal

- Voorkomt lekkage (ook tijdens langdurige toediening), contaminatie en luchtembolieën.
- Bestand tegen schadelijke effecten van farmaceutische middelen.



Poort met een glad oppervlak

- Voorkomt microbiologisch contaminatie.



Klikt bij iedere draaibeweging van 45°

- Een voelbare klik bevestigt de juiste positie van de kraan (45°).
- Injecteren en aspireren kan eenvoudig door de adapter te draaien.



Discofix® CSF - het gesloten systeem

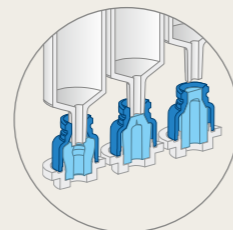

Zelfsluitende poort

- Voorkomt blootstelling aan schadelijke medicatie.
- Voorkomt chemische contaminatie.
- Geen afsluitdop nodig.

Standaard verlenglijnen

Type Heidelberg

Verlengt IV-sets gemakkelijk zonder lengtebeperking.

Geen beperkte flow voor alle standaardtoepassingen.



De lijn heeft een binnen diameter van 3 mm.

Niet te gebruiken als verlenglijn voor spuitpompen.

Beschikbaar in verschillende lengtes: van 30 tot 190 cm.

Perfusor® verlenglijnen

Voor Perfusor® Space® en Space®plus pompen

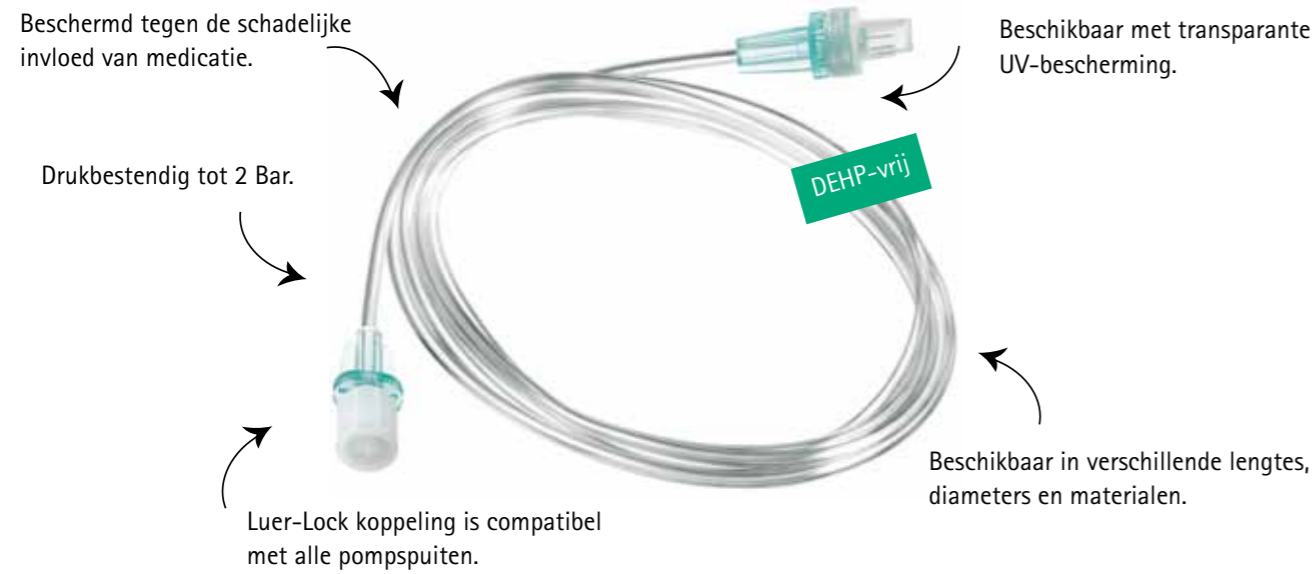

Perfusor® lijn met Safesite®

- Automatische bescherming tegen free-flow.
- Klinisch bewezen bio-compatibiliteit.



Perfusor® lijn met Sterifix®

- Partikelfilter van 0,2 µm.
- Minimaal restvolume.



Perfusor® lijn Space®plus

- Kleurcodering voor snelle identificatie.
- Laag priming volume.
- In drie verschillende kleuren.



Perfusor® lijn PE

- Minimaal restvolume.
- Verschillende lengtes van 10 cm tot 300 cm.
- Lekvrij.



Perfusor® lijn PVC

- Twee verschillende binnendiameters: 0,9 mm en 1,5 mm.
- Verschillende lengtes van 10 cm tot 700 cm.

Spiraallijnen

Meer flexibiliteit voor de patiënt

Voordelen ziekenhuis



Besparing van tijd.



Verlaging van algemene proceskosten.



Minder fouten bij gebruik.



Minder afval door vermindering van verpakking.



Verkleint het risico op contaminatie.



Meer veiligheid door standaardisatie.

Voordelen gebruiker



Vermindert het risico op contaminatie.



Geoptimaliseerde processen verlichten werklust.



Gebruiksklare custom made sets.



Veiligheid door standaardisatie.

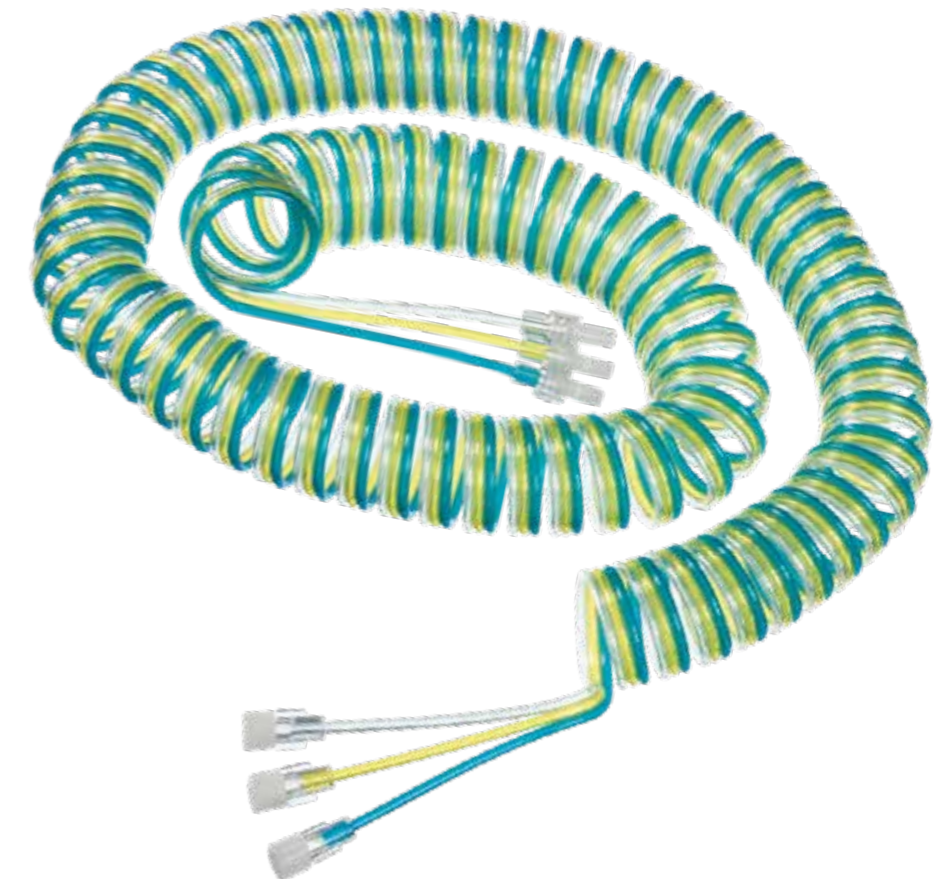

Filters

Voorkomen is de beste bescherming

Risico's van partikelcontaminatie:

- Aantasting van de microcirculatie.
- Blokkades van bloedvaten en schade aan verschillende organen.
- Bloedvatontsteking.
- Naast de risico's voor de patient leidt dit tot extra kosten en een langere verblijfsduur.



Voordelen gebruiker

- Retentie van partikels en micro-organismen.
- Bescherming tegen luchtembolie.
- Detectie van incompatibiliteit.
- Minder complicaties.
- Kortere verblijfsduur op de IC.
- Kostenbesparing.

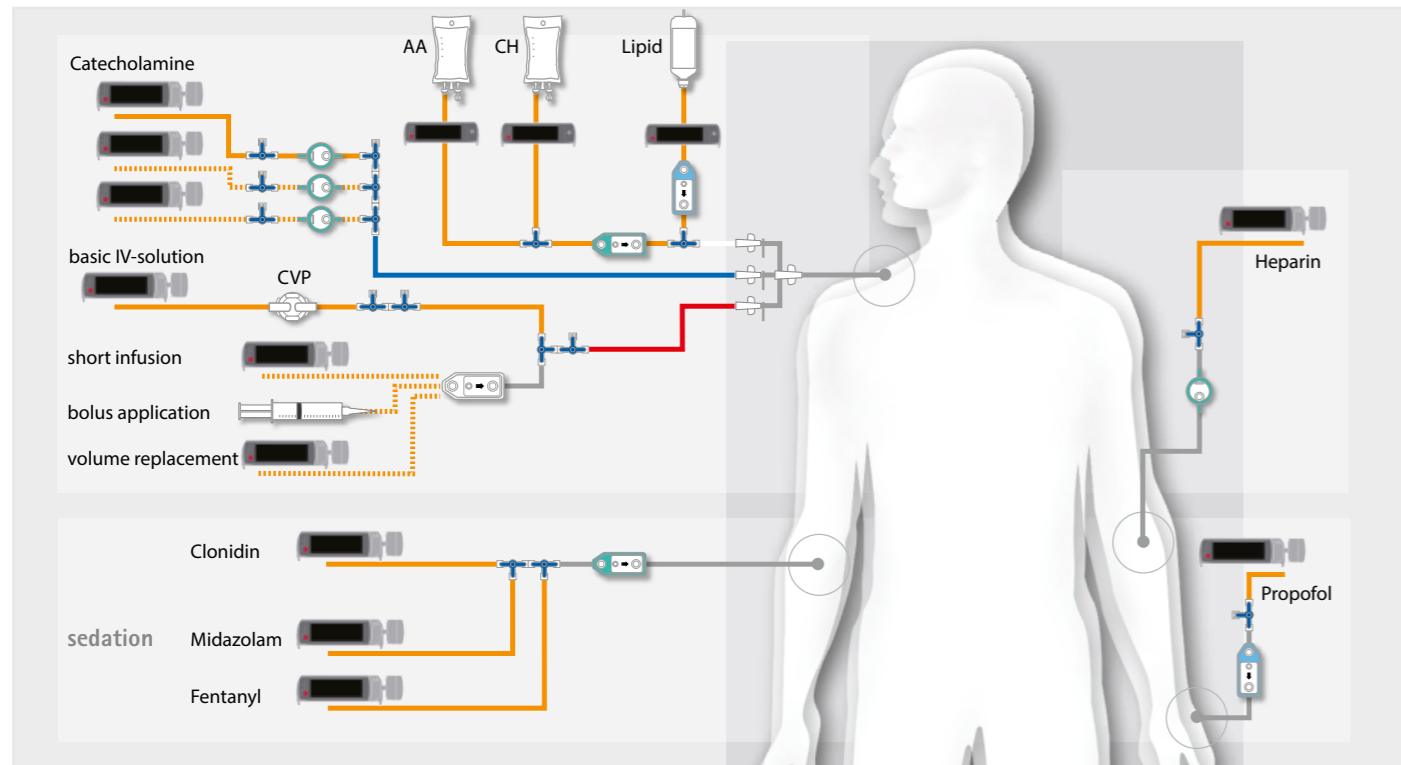

Afsluitdoppen, back-check valve en adapters

Betrouwbare connectoren voor alle therapieën

Afsluitdoppen



Combi-stopper

- Snel en eenvoudig afsluiten van naaldvrije injectiepoorten en voorgevulde spuit.
- Luer-Lock en Luer-Slip verbindingen mogelijk.



In stopper

- Een toegangspoort voor naalden via een latexvrij membraan.
- Gesloten naald injectiepoort.
- Eenvoudig in gebruik.

Swabcap®



Swabcap®

- Gepatenteerde gesloten dop.
- Continue desinfectie hub en schroefdraad.
- Desinfectie na 30 seconden (70% IPA).
- Langdurig effect tot 7 dagen.
- Altijd effectief.
- Steriele verpakking voor veilig werken.
- Medische spons, geen partikelcontaminatie.



Terugslagkleppen



Terugslagkleppen

- Medicatieresistent.
- Voorkomt terugvloeiing.
- Meer veiligheid tijdens IV-toediening.
- Geen bloedreflux.
- Meerdere terugslagkleppen voor elke toepassing.

Adapters



Combifix® adapter voor mannelijk/mannelijk connectie.



Combifix® adapter voor vrouwelijk/vrouwelijk connectie.



Visuele controle



Goede grip



Eenvoudig te reinigen



Eenvoudig te koppelen



Voordelen gebruiker

- Beschermt tegen microbiologische contaminatie.
- Eenvoudig in gebruik.
- Bestand tegen hoge druk.
- Medicatie compatibel.
- Positieve verplaatsing voorkomt occlusie van de katheter.

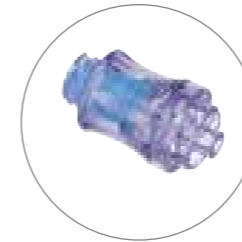

Safeflow

Naaldvrije toegang voor injectie, aspiratie of parallelle infusies als een gesloten systeem.



PVC/DEHP-vrij Neutrapur® lijn

- Bijzonder patiëntvriendelijk.
- Geen weekmakers.
- Ecologisch verantwoord.

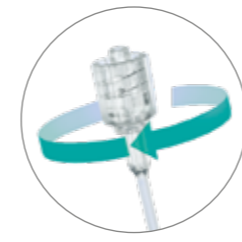

Roterende Luer-lock connector

Maakt een veiligere en gemakkelijkere verbinding mogelijk zonder de lijn te draaien.



Voordelen gebruiker

- Desinfecteerbaar.
- Compatibel met Luer-slip en Luer-lock.
- Meervoudige toegang voor directe aspiratie of injectie.
- Geschikt voor alle IV-sets.



Nauwkeurigheid in voorbereiding, injectie en toepassing

Nauwkeurigheid in voorbereiding, injectie en toepassing: B. Braun biedt een breed assortiment aan spuit en naalden voor eenmalig gebruik.

Het assortiment aan spuit en voor eenmalig gebruik omvat 2- en 3-delige spuit en, fijn-doseringsspuit en (waaronder Low Dead Space-versies) en spuit en voor speciale toepassingen zoals heparine en insuline met speciale schalen. Het omvat verder Original Perfusor[®]-spuit en, kathetertipspuit en, orale spuit en spuit en met ENFit[®]- en NRFit[®]-connectoren.

Het assortiment aan naalden voor eenmalig gebruik omvat naalden voor insulinepennen, traditionele injectienaalden, stompe naalden, veiligheidsnaalden en medicatiemengnaalden.

Overzicht B. Braun spuiten

Standaard spuiten

Maat	2-delige spuiten			3-delige spuiten		
	Luer		Luer Lock	Luer		Luer Lock
	Solo	Duo	Solo	Solo	Duo	Solo
2 ml	■	■	■	■	■	■
3 ml				■	■	■
5 ml	■	■	■	■	■	■
10 ml	■	■	■	■	■	■
20 ml	■	■	■	■	■	■
30 ml				■		■
50 ml				■		■

Speciale spuiten

Maat	2-delige spuiten		3-delige spuiten					
	Orale dispenser		"Loss of Resistance" spuit		Original Perfusor® spuit	Kathetertip	NRFit®	ENFit®
			Luer & Luer Lock	NRFit® Slip & Lock	met en zonder aspiratiennaald	NRFit® Lock		Slip & Lock
2 ml	■							■
3 ml								■
5 ml	■							■
8 ml		■	■					
10 ml	■							■
20 ml	■				■			■
50 ml					■	■	■	■
60 ml								■
100 ml							■	

Fijne doseerspuiten

Maat	2-delige spuiten			3-delige spuiten				
	Luer		Orale dispenser	Luer	Luer Lock	NRFit® Slip	ENFit®	met geïntegreerde naald
	Solo	Duo		Solo	Duo	Solo		30 G x 12 mm
1 ml niet LDS				■	■	■	■	
1 ml LDS	■	■	■					■

Insulinespuiten

Graduatie	Maat	2-delige spuiten		3-delige spuiten		3-delige spuiten	
		Luer		Luer		met geïntegreerde naald	
		Solo	Duo 26 G x 12 mm	Solo	Duo 26 G x 12 mm	30 G x 8 mm	30 G x 12 mm
U-40	0.5 ml					■	
	1 ml	■	■	■	■	■	■
U-100	0.5 ml					■	■
	1 ml			■	■	■	■



Overzicht B. Braun naalden



Onderhuidse-, meng- en pennaalden

Gauge	Lengte (inch)	Lengte	Onderhuidse naalden			Mengnaalden			Pennaalden	
			Sterican®	Sterican® Safety Needle	Sterican® Blunt	Sterican® MIX	Sterifix® Filter Needle	Aspiration needle	Omnican® fine	Omnican® fine Comfort
32 G	3/16"	4 mm							■	
	1/4"	6 mm							■	
31 G	3/16"	4 mm							■	■
	1/4"	6 mm							■	■
30 G	5/16"	8 mm							■	■
	1/2"	12/13 mm	■	■						
29 G	1/2"	12 mm							■	■
	1/2"	12/13 mm	■	■						
27 G	3/4"	20 mm	■							
	1"	25 mm	■							
	1 1/2"	40 mm	■		■					
26 G	1/2"	12/13 mm	■	■						
	1"	25 mm	■							
25 G	5/8"	16 mm	■	■						
	1"	25 mm	■	■						
24 G	1 1/2"	40 mm	■	■						
	1"	25 mm	■	■						
23 G	1 1/4"	30 mm	■	■						
	1 1/2"	40 mm		■						
	2 3/8"	60 mm	■							
	3 1/8"	80 mm	■							
22 G	1"	25 mm		■						
	1 1/4"	30 mm	■	■						
	1 1/2"	40 mm	■	■						
	2"	50 mm	■							
21 G	7/8"	22 mm			■					
	1"	25 mm	■	■						
	1 1/4"	30 mm		■						
	1 1/2"	40 mm	■	■						
	2"	50 mm	■							
	3 1/8"	80 mm	■							
	4 3/4"	120 mm	■							
20 G	1"	25 mm	■	■						
	1 1/2"	40 mm	■	■						
	2"	50 mm	■							
	2 3/4"	70 mm	■							
19 G	1"	25 mm						■		
	1 1/4"	30 mm	■							
	1 1/2"	40 mm	■	■						
18 G	2"	50 mm	■							
	1"	25 mm		■						
14 G	1 1/2"	40 mm	■	■			■			
	2"	50 mm	■				■			
14 G	1 1/10"	28 mm							■	
	1 1/4"	30 mm							■	

Discofix® C kranenblokken

3-wegkraan

Discofix® C kranenblok met fixatieplaat	Kleur	Roterende adapter	Proximale 3-wegkraan	Verleng lijn (cm)	Verlenglijn DEHP-vrij	Binnen verpakkingseenheid	Artikelnummer
	■ ■ ■ ■	■	-	-	-	50	16600C
	■ ■ ■ ■	■	-	-	-	50	16605C
	■ ■ ■ ■	■	-	75	■	50	4085213
	■ ■ ■ ■	■	■	180	■	50	16611C
	■ ■ ■ ■	■	-	200	■	50	4085168
	■ ■ ■ ■	■	■	150	■	50	16610C
	■ ■ ■ ■	■	-	150	■	50	16615C
	■ ■ ■ ■ ■ ■	■	-	-	-	40	16608C
	■ ■ ■ ■ ■ ■	■	-	-	-	40	16609C
	■ ■ ■ ■ ■ ■	■	-	150	■	40	16612C
	■ ■ ■ ■ ■ ■	■	■	150	■	40	16613C
	■ ■ ■ ■ ■ ■	■	-	100	■	40	4085230
	■ ■ ■ ■ ■ ■	■	■	180	■	40	16614C
	■ ■ ■ ■ ■ ■	■	-	200	■	40	4083777

Discofix® CSF	Kleur	Roterende adapter	Proximale 3-wegkraan	Verleng lijn (cm)	Verlenglijn DEHP-vrij	Binnen verpakkingseenheid	Artikelnummer
	■ ■ ■ ■	■	-	-	-	50	4085300SF
	■ ■ ■ ■ ■ ■	■	-	-	-	40	4085500SF
	■ ■ ■ ■	■	-	150	■	50	4085434SF
	■ ■ ■ ■ ■ ■	■	-	150	■	50	4085450SF

Discofix® C kranenblokken

3-wegkraan















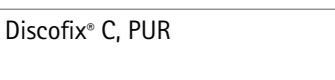

Discofix® C kranenblok zonder fixatieplaat	Kleur	Roterende adapter	Proximale 3-wegkraan	Verleng lijn (cm)	Verlenglijn DEHP-vrij	Binnen verpakkingseenheid	Artikelnummer
	■ ■ ■ ■	■	-	-	-	50	16800C
	□ ■ ■ ■	■	-	-	-	50	16801C
	■ ■ ■ ■	■	-	-	-	50	16900C
	■ ■ ■ ■	■	-	-	-	50	16901C

Combi-Holder	Productomschrijving	Verpakkingseenheid	Artikelnummer
	Combi-holder, geschikt voor kranenblokken	1	4086007

Perifix® PinPad	Productomschrijving	Verpakkingseenheid	Artikelnummer
	Perifix® PinPad Filter Fixation	50	4515510







Discofix® C

3-wegkraan

3-wegkranen	Kleur	Roterende adapter	Verlenglijn (cm)	Verlenglijn DEHP-vrij	Binnen verpakkingseenheid	Artikelnummer
Discofix® C	■	■	-	-	100	16494C
	□	■	-	-	100	16495C
	■	■	-	-	100	16496C
	■	■	-	-	100	16497C
	■	■	10	■	50	16502C
	□	■	10	■	50	16504C
	■	■	25	■	50	16520C
	■	■	50	■	50	16540C
	■	■	75	■	50	16551C
	■	■	100	■	50	16560C
Discofix® C, PUR	■	■	10	-	50	16700C
	□	■	10	-	50	16701C
	■	■	25	-	50	16720C
	■	■	50	-	50	16740C
	■	■	75	-	50	16751C
	■	■	100	-	50	16760C
Discofix® CSF	■	■	-	-	100	16494CSF
	□	■	-	-	100	16495CSF
	■	■	10	■	50	16500CSF
	□	■	10	■	50	16501CSF
	■	■	25	■	50	16520CSF
	■	■	50	■	50	16540CSF
	■	■	75	■	50	16551CSF
	■	■	100	■	50	16560CSF





Discofix® C

3-wegkraan

3-wegkranen	Kleur	Roterende adapter	Verlenglijn (cm)	Verlenglijn DEHP-vrij	Binnen verpakkingseenheid	Artikelnummer
Discofix® 3-wegkraan	■	■	-	-	200	4095111
	■	■	-	-	200	4095120
	□	■	-	-	200	4095146
	■	-	10	■	100	4098102
	■	-	25	■	100	4098218
	■	-	50	■	100	4098501
	■	-	75	■	100	4098234
	■	-	100	■	100	4098080





Standaard verlenglijnen

Type Heidelberg

Verlenglijnen Type Heidelberg	Lengte (cm)	Priming volume (ml)	Doorsnede Ø (mm)	Materiaal	Binnen verpakkingseenheid	Artikelnummer
	30	2.1	3.0	PVC (DEHP-vrij)	100	4097300
	75	5.3	3.0	PVC (DEHP-vrij)	100	4097173
	100	7.1	3.0	PVC (DEHP-vrij)	100	4097262
	140	9.9	3.0	PVC (DEHP-vrij)	100	4097408
	190	13.4	3.0	PVC (DEHP-vrij)	100	4097190

Standaard verlenglijnen

Type Heidelberg

Verlenglijnen Type Heidelberg	Lengte (cm)	Priming volume (ml)	Doorsnede Ø (mm)	Materiaal	Binnen verpakings- eenheid	Artikelnummer
LS-2 connector 	11	1.7	3.0	PVC (DEHP-vrij)	100	4097122
LS-4 connector 	31	5.5	3.0	PVC (DEHP-vrij)	100	4097149
LS-5 connector 	30	2.5	3.0	PVC (DEHP-vrij)	100	4097157
Verbindingslijn met injectiepoort 	9	1.2	3.0	PVC (DEHP-vrij)	100	4247116
Terugslagklep verlengset	25		3.0	PVC (DEHP-vrij)	100	471980

Perfusor® verlenglijnen

Voor Perfusor® Space®plus

Minimum-volume verlenglijn met side- klem PVC	Lengte (cm)	Priming volume (ml)	Doorsnede Ø (mm)	Materiaal	Binnen verpakings- eenheid	Artikelnummer
	10	0.3	0.9	PVC (DEHP-vrij)	200	4054394
	30	0.3	0.9	PVC (DEHP-vrij)	200	9500049
	75	0.6	0.9	PVC (DEHP-vrij)	100	9500057
	140	1.0	0.9	PVC (DEHP-vrij)	100	9500065
	180	1.2	0.9	PVC (DEHP-vrij)	100	4097572

Perfusor® verlenglijnen

Voor Perfusor® Space®plus



Perfusor® verlenglijn PVC	Lengte (cm)	Priming volume (ml)	Doorsnede Ø (mm)	Materiaal	Binnen verpakings- eenheid	Artikelnummer
	75	0.6	0.9	PVC (DEHP-vrij)	100	8722870N
	150	1.0	0.9	PVC (DEHP-vrij)	100	8255504N
	200	1.4	0.9	PVC (DEHP-vrij)	100	8745919N
	25	0.4	1.5	PVC (DEHP-vrij)	100	0066088K
	65	0.9	1.5	PVC (DEHP-vrij)	100	8255172
	100	1.8	1.5	PVC (DEHP-vrij)	100	0009483H
	150	2.6	1.5	PVC (DEHP-vrij)	100	8722960
	200	3.5	1.5	PVC (DEHP-vrij)	100	8722862
	250	4.4	1.5	PVC (DEHP-vrij)	100	8255490
	300	5.3	1.5	PVC (DEHP-vrij)	100	8255253
	700	12.3	1.5	PVC (DEHP-vrij)	100	8250803



Perfusor® verlenglijn PE	Lengte (cm)	Priming volume (ml)	Doorsnede Ø (mm)	Materiaal	Binnen verpakings- eenheid	Artikelnummer
	10	0.1	1.0	PE (PVC-vrij)	100	0066086H
	25	0.2	1.0	PE (PVC-vrij)	100	0066087J
	50	0.4	1.0	PE (PVC-vrij)	100	8255059
	100	0.8	1.0	PE (PVC-vrij)	100	8255067
	150	1.2	1.0	PE (PVC-vrij)	100	8722935
	200	1.6	1.0	PE (PVC-vrij)	100	8723060
	250	2.0	1.0	PE (PVC-vrij)	100	8272565
	300	2.4	1.0	PE (PVC-vrij)	100	8250146

Perfusor® verlenglijn met UV-bescherming	Lengte (cm)	Priming volume (ml)	Doorsnede Ø (mm)	Materiaal	Binnen verpakings- eenheid	Artikelnummer
	150	1.2	1.0	PE (PVC-vrij)	100	8723017
	200	1.6	1.0	PE (PVC-vrij)	100	8723018

Speciale verlenglijnen

Meer flexibiliteit voor elke therapie

Original Perfusor® lijnen Space ^{plus}	Kleur	Lengte (cm)	Priming volume (ml)	Doorsnede Ø (mm)	Materiaal	Binnen verpakkingseenheid	Artikelnummer
	■	150	1.27	1.0 x 2.0	PE	100	8723020
	■	200	1.67	1.0 x 2.0	PE	100	8723021
	■	150	1.27	1.0 x 2.0	PE	100	8723025
	■	200	1.67	1.0 x 2.0	PE	100	8723026
	■	150	1.27	1.0 x 2.0	PE	100	8723023
	■	200	1.67	1.0 x 2.0	PE	100	8723024

Original Perfusor® lijnen Type Enteral Nutrition ENFit®	Lengte (cm)	Priming volume (ml)	Doorsnede Ø (mm)	Materiaal	Binnen verpakkingseenheid	Artikelnummer
	150	1.1	0.9	PVC (DEHP-vrij)	25	87229930
	150	7.6	2.5	PVC (DEHP-vrij)	25	87229910

Original Perfusor® lijn Type Epidural NRFit®	Lengte (cm)	Priming volume (ml)	Doorsnede Ø (mm)	Materiaal	Binnen verpakkingseenheid	Artikelnummer
	200	2.8	1.3	PUR (Neutrapur)	25	8722865

Spiraallijnen











Meer flexibiliteit voor de patiënt

Proset Spiraallijn single lumen	Lengte (cm)	Priming volume (ml)	Doorsnede Ø (mm)	Materiaal	Kleur	Binnen verpakkingseenheid	Artikelnummer
	150	1.2	1.0	PUR (DEHP-vrij)	□	50	4090365
	300	2.4	1.0	PUR (DEHP-vrij)	□	50	4090373
	300	2.4	1.0	PUR (DEHP-vrij)	■	50	4092946
	500	3.9	1.0	PUR (DEHP-vrij)	□	50	4092953
	700	5.5	1.0	PUR (DEHP-vrij)	□	50	4092961
	850	6.7	1.0	PUR (DEHP-vrij)	□	50	4092970
	150	4.7	2.0	PUR (DEHP-vrij)	□	50	4092937
	300	9.4	2.0	PUR (DEHP-vrij)	□	50	4092945
	500	15.7	2.0	PUR (DEHP-vrij)	□	50	4090438
	700	22	2.0	PUR (DEHP-vrij)	□	50	4090381
	850	26.7	2.0	PUR (DEHP-vrij)	□	50	4090390

Proset spiraallijn double lumen	Lengte (cm)	Priming volume (ml)	Doorsnede Ø (mm)	Materiaal	Kleur	Binnen verpakkingseenheid	Artikelnummer
	300	2.4	1.0	PUR (DEHP-vrij)	■ □	50	4091752
	500	3.9	1.0	PUR (DEHP-vrij)	■ □	50	4099362
	700	5.5	1.0	PUR (DEHP-vrij)	■ □	50	4093607
	850	6.7	1.0	PUR (DEHP-vrij)	■ □	50	4091728
	700	22	2.0	PUR (DEHP-vrij)	■ □	50	4093870
	800	26.7	2.0	PUR (DEHP-vrij)	■ □	50	4093885









ProSet spiraallijnen



Meer flexibiliteit voor de patiënt

Proset Spiraallijn triple lumen	Lengte (cm)	Priming volume (ml)	Doorsnede Ø (mm)	Materiaal	Kleur	Binnen verpakings- eenheid	Artikelnummer
	150	1.2	1.0	PUR (DEHP-vrij)		50	4093115
	300	2.4	1.0	PUR (DEHP-vrij)		50	4093130
	500	3.9	1.0	PUR (DEHP-vrij)		50	4093150
	700	5.5	1.0	PUR (DEHP-vrij)		50	4093170
	850	6.7	1.0	PUR (DEHP-vrij)		50	4093185
	150	4.7	2.0	PUR (DEHP-vrij)		50	4093215
	300	9.4	2.0	PUR (DEHP-vrij)		50	4093230
	500	15.7	2.0	PUR (DEHP-vrij)		50	4093250
	700	22	2.0	PUR (DEHP-vrij)		50	4093270
	800	26.7	2.0	PUR (DEHP-vrij)		50	4093285

Filters







Voorkomen is de beste bescherming

Product	Grootte porie	Grootte filter (cm ²)	Grootte filter ml/min	Vulvolume		Tubing diameter	Aanbevolen gebruiks- tijd	Binnen verpakings- eenheid	Artikel- nummer
				Filter (ml)	Totaal (ml)				
Intrapur® Plus 	0.2 µm	10	> 20	2.4	3.46	PVC 2 x 4.1	96 u	50	4099800
Intrapur® Plus 	0.2 µm	10	> 20	2.4	4.54	PUR 3 x 4.1	96 u	50	4183916
Intrapur® Neonat 	0.2 µm	1.65	> 2	0.4	0.76	PUR 1 x 2.35	96 u	50	4099451
Intrapur® Lipid 	1.2 µm	10	> 100	2.4	3.46	PVC 2 x 4.1	24 u	50	4099702
Intrapur® Paed Lipid 	1.2 µm	4.5	> 90	0.7	1.19	PVC 1.2 x 2.2	24 u	50	4099850
Intrapur® Neonat Lipid 	1.2 µm	1.65	> 30	0.4	0.76	PUR 1 x 2.35	24 u	50	4099460
Sterifix® 	0.2 µm	10	> 20	2.4	3.46	PVC 2 x 4.1	24 u	50	4099303
Sterifix® 	0.2 µm	10	> 20	2.4	4.54	PUR 3 x 4.1	24 u	50	4184637
Sterifix® Paed 	0.2 µm	4.5	> 10	0.7	-	Geen tubing	24 u	50	4099354



Injectie en aspiratiefilters	Partikel retentie	Bacterie retentie	Speciale eigenschappen	Poriegrootte (µm)	Binnen verpakings- eenheid	Artikelnummer
Sterifix® injectiefilter 	■	■	Geschikt voor spuiten	0.2	200	4099206
Sterifix® Pury 	■		Geschikt voor spuiten	5	100	4551001



De naaldvrije connector

Caresite®	Productomschrijving	Lengte (cm)	Priming volume (ml)	Lijn Ø (mm)	Latex vrij	DEHP vrij	Binnen verpakkingseenheid	Artikelnummer
	Caresite®	-	0.22		■	■	100	415122-01

Caresite® verlenglijn	Productomschrijving	Lengte (cm)	Priming volume (ml)	Lijn Ø (mm)	Latex vrij	DEHP vrij	Binnen verpakkingseenheid	Artikelnummer
	Smallbore verlenglijn set met Caresite®, Spin-Lock (hoge druk - voor injecties)	20	0.5	1.3	■	■	100	470100-01
	Stenard bore verlenglijn set met Caresite®, Spin-Lock	15	0.9	2.8	■	■	100	470108-01
	Smallbore 2x verlenglijn set met 2 Caresite®, Spin-Lock	18	0.9	1.3	■	■	100	470106-01
	Smallbore 2x verlenglijn set met 2 Caresite®, 2 back-check valves, Spin-Lock	22	1.6	1.3	■	■	100	470182
	Smallbore 3x verlenglijn set met 3 Caresite®, Spin-Lock	20	1.3	1.3	■	■	50	470160
	Smallbore 3x verlenglijn set met 3 Caresite®, 3 back-check valves, Spin-Lock	22	2.0	1.3	■	■	50	470161



De naaldvrije connector

Safeflow	Productomschrijving	Lengte (cm)	Priming volume (ml)	Lijn Ø (mm)	Latex vrij	DEHP vrij	Binnen verpakkingseenheid	Artikelnummer
	Safeflow valve, blauw	-	0.09 ml	-	■	■	50	409100H
	Safeflow valve, rood	-	0.09 ml	-	■	■	50	409110H

Safeflow verlenglijn	Productomschrijving	Lengte (cm)	Priming volume (ml)	Lijn Ø (mm)	Latex vrij	DEHP/PVC vrij	Binnen verpakkingseenheid	Artikelnummer
	Smallbore Verlenglijn Set met Safeflow	10	0.22	1.0	■	■	100	4097154N
	Smallbore Y-Verlenglijn Set met 2 Safeflow	12	0.38	1.0	■	■	100	4097145N
	Smallbore Y-Verlenglijn Set met 2 Safeflow en back-check valve	12	0.66	1.0	■	■	100	4097148N



Afsluitdoppen, back-check valves en adapters



Betrouwbare connectoren voor alle therapieën





Afsluitdoppen	Productomschrijving	Binnen verpakkingseenheid	Artikelnummer
	■ Combi-Stopper	100	4495101
	■ Combi-Stopper	100	4495152
	□ Combi-Stopper	100	4495209
	■ Combi-Stopper 10 x	100	4188178
	■ Combi-Stopper 10 x	100	4188179
	■ Combi-Stopper 25 x	100	4188185
	■ Combi-Stopper 25 x	100	4188186
	■ Combi-Stopper 100 x	50	4182545
	■ Combi-Stopper 100 x	50	4182553
	■ In-stopper	100	4238010
	Afsluitdop Luer-Lock	100	4097077

Adapters	Productomschrijving	Binnen verpakkingseenheid	Artikelnummer
	Combifix® adapter vrouwelijk/vrouwelijk	100	5206634
	Combifix® adapter mannelijk/mannelijk	100	5206642

Ontluchtingssystemen	Productomschrijving	Binnen verpakkingseenheid	Artikelnummer
	Beluchttingsnaald 1.1 x 30 mm met bacteriefilter	100	4190060

Back-check valves	Productomschrijving	Drukweerstand	Openingsweerstand	Verpakkingseenheid	Artikelnummer
	Infuvalve® BCV voor applicatie met standaard oplossingen	+ ≤ 2 bar	+ ≤ 2 mbar	500	4094000N
	Infuvalve® BCV voor applicatie met specifieke drugs (drug resistent)	5 bar	+ ≤ 15 mbar	500	4094000C
	BCV Assy (spuitdruk nodig)	+ ≤ 2 bar	100-300 mbar	100	415062



PureSites	Productomschrijving	Verpakkingseenheid	Artikelnummer
	Closed male connector	100	4551100
	Dust cover cap	200	4551101

Spoel en ontsmettingsoplossingen	Productomschrijving	Volume	Verpakkingseenheid	Artikelnummer
	SwabCap® Valve Cap met 70% IPA	-	200	EM-SCXT3
	Omniflush® met SwabCap® 10 ml in 10 ml	10 ml 0.9% Natriumchloride (NaCl)	100	EM-3513576SC
	Omniflush® met SwabCap® 5 ml in 10 ml	5 ml 0.9% Natriumchloride (NaCl)	100	EM-3513575SC
	Omniflush® met SwabCap® 3 ml in 10 ml	3 ml 0.9% Natriumchloride (NaCl)	100	EM-3513572SC

Spuiten

Luer-Lock en Luer-Slip

Omnifix® Luer-Slip spuit	Productomschrijving	Volume (ml)	Schaalverdeling (ml)	Binnen verpakkingseenheid	Artikelnummer
	Omnifix® Luer-Solo en Luer-Slip	1	0.1	1800	9161406V
		2	0.1	2500	4616022V
		3	0.1	2400	4616025V
		5	0.2	2000	4616057V
		10	0.5	1200	4616103V
		20	1.0	800	4616200V
		30	1.0	600	4616308F
		50	1.0	100	4616502F

Omnifix® Luer-Lock spuit	Productomschrijving	Volume (ml)	Schaalverdeling (ml)	Binnen verpakkingseenheid	Artikelnummer
	Omnifix® Luer-Solo en Luer-Lock	1	0.01	2400	9167006V
		2	0.1	2500	4617029V
		3	0.1	2400	4617022V
		5	0.2	2000	4617053V
		10	0.5	1200	4617100V
		20	1.0	800	4617207V
		30	1.0	600	4617304F
	Omnifix® Luer-Solo en Luer-Lock UV-bescherming tot 520 nm	50	1.0	100	4617509F
		50	1.0	100	4617510F-06

Beschrijving	Volume (ml)	Cone	Maximaal volume (ml)	Eenheid per doos	Artikelnummer
Perifix® LOR, Luer	8 ml	Centric	8.0 ml	25 stuks	4637100
Perifix® LOR, Luer Lock					4638107

Spuiten

Perfusor® en enteraal

Perfusor® spuiten	Productomschrijving	Volume (ml)	Schaalverdeling (ml)	Binnen verpakkingseenheid	Artikelnummer
	Luer-Lock	20	1	50	8728615
	Incl. de 30 mm naald, Ø 2 mm	20	1	50	8728623
	Luer-Lock	50	1	100	8728844F-06
	Incl. de 30 mm naald, Ø 2 mm	50	1	100	8728810F-06
	Incl. 28 mm 15µm filternaald, Ø 2 mm	50	1	100	8728852F-06
	Transparant UV-bescherming 520 nm, incl. 15 mm filternaald, Ø 2 mm	50	1	100	8728861F-06

Enterale spuit (type ENFit®)	Volume (ml)	Cone	Schaalverdeling (ml)	Maximaal volume (ml)	Binnen verpakkingseenheid	Artikelnummer
	1	Centric	0.01	1,0	200	4616024-01
	2.5	Eccentric	0.10	2,5	200	4616025-01
	5	Eccentric	0.10	5,0	200	4616026-01
	10	Eccentric	0.10	10,0	200	4616027-01
	20	Eccentric	1.00	20,0	100	4616028-01
	60	Eccentric	1.00	60,0	100	4616029-01

Spuiten

NRFit®

Original® Perfusor® spuit	Volume (ml)	Cone	Schaalverdeling (ml)	Binnen verpakkingseenheid	Artikelnummer
	50	Centric	0.01	100	8728845F-01

Omnifix® NRFit® Luer-Slip spuit	Volume (ml)	Cone	Schaalverdeling (ml)	Binnen verpakkingseenheid	Artikelnummer
	1	Centric	0.1	2400	9164001
	3	Centric	0.1	100	4616003
	5	Centric	0.2	100	4616005
	10	Centric	0.5	100	4616014
	20	Centric	1.0	100	4616021

Omnifix® NRFit® Luer-Lock spuit	Volume (ml)	Cone	Schaalverdeling (ml)	Binnen verpakkingseenheid	Artikelnummer
	3	Centric	0.1	100	4617003
	5	Centric	0.2	100	4617006
	10	Centric	0.5	100	4617014
	20	Centric	1.0	100	4617021
	50	Centric	1.0	100	4617508F-01

Beschrijving	Volume (ml)	Cone	Totale schaalverdeling (ml)	Eenheid per doos	Artikelnummer
Perifix® LOR, NRFit® Slip	8 ml	Centric	8.0 ml	25 stuks	4637110
Perifix® LOR, NRFit® Lock					4638110

Hypodermische standaard-, stompe en veiligheidsnaalden

Sterican®, Sterican® Blunt en Sterican® Safety Needle

Voor injectie biedt B. Braun een uitgebreid assortiment naalden voor eenmalig gebruik met korte en lange schuine vlakken voor standaardtoepassingen. Het gamma omvat ook stompe naalden en veiligheidsnaalden.



Standaard hypodermische naalden met Luer Lock-connector en schuine puntlengte volgens indicatie

Producteigenschappen

- Gemaakt van roestvrij chroomnikkelstaal
- Transparante Luer Lock plastic naaf gemaakt uit polypropyleen
- Siliconen coating
- Afschuining met drie facetten
- Naaf met kleurcodering in overeenstemming met ISO 6009
- Vrij van PCV, latex, DEHP en BPA
- Steriele enkelvoudige verpakking
- Doos van 100 stuks

Gebruikersvoordelen

- Glad oppervlak door fijn gedoseerde siliconencoating
- Afschuinlengte volgens indicatie
- Kleurgecodeerde naaf voor eenvoudigere identificatie van de buitenste naalddiameter
- Compatibel met alle standaard Luer- en Luer Lock-spuiten
- Verkrijgbaar in naalddiktes variërend van 30 G - 18 G, breed gamma voor injecties en bloedafnames bij verschillende patiënten en op verschillende injectieplaatsen



Gauge x lengte (inch)	Ø x lengte	Punttype	Eenheid per doos	Referentienummer
30 G x 1/2 "	0.30 x 12 mm	Lange punt	4000 stuks	4656300B
27 G x 1/2 "	0.40 x 12 mm	Lange punt	4000 stuks	4665406B
27 G x 3/4 "	0.40 x 20 mm	Lange punt	4000 stuks	4657705B
27 G x 1 "	0.40 x 25 mm	Lange punt	4000 stuks	9186174B
27 G x 1 1/2 "	0.40 x 40 mm	Lange punt	4000 stuks	9186182B
26 G x 1/2 "	0.45 x 12 mm	Lange punt	4000 stuks	4665457B
26 G x 1 "	0.45 x 25 mm	Lange punt	4000 stuks	4657683B
25 G x 5/8 "	0.50 x 16 mm	Lange punt	4000 stuks	4657853B
25 G x 1 "	0.50 x 25 mm	Lange punt	4000 stuks	9186158B
25 G x 1 1/2 "	0.50 x 40 mm	Lange punt	4000 stuks	9186166B
24 G x 1 "	0.55 x 25 mm	Lange punt	4000 stuks	4657675B
23 G x 1 "	0.60 x 25 mm	Lange punt	4000 stuks	4657667B
23 G x 1 1/4 "	0.60 x 30 mm	Lange punt	4000 stuks	4657640B
23 G x 2 3/8 "	0.60 x 60 mm	Lange punt	3000 stuks	4665600B
23 G x 3 1/8 "	0.60 x 80 mm	Lange punt	1000 stuks	4665635
22 G x 1 1/4 "	0.70 x 30 mm	Lange punt	4000 stuks	4657624B
22 G x 1 1/2 "	0.70 x 40 mm	Lange punt	4000 stuks	4660021B
22 G x 2 "	0.70 x 50 mm	Lange punt	3000 stuks	4650018B
21 G x 1 "	0.80 x 25 mm	Lange punt	4000 stuks	4657543B
21 G x 1 1/2 "	0.80 x 40 mm	Lange punt	4000 stuks	4657527B
21 G x 2 "	0.80 x 50 mm	Lange punt	3000 stuks	4665503B
21 G x 3 1/8 "	0.80 x 80 mm	Lange punt	1000 stuks	4665465
21 G x 4 3/4 "	0.80 x 120 mm	Lange punt	1000 stuks	4665643
20 G x 1 "	0.90 x 25 mm	Lange punt	4000 stuks	4657500B
20 G x 1 1/2 "	0.90 x 40 mm	Lange punt	4000 stuks	4657519B
20 G x 2 "	0.90 x 50 mm	Korte punt	3000 stuks	4667093B
20 G x 2 3/4 "	0.90 x 70 mm	Lange punt	3000 stuks	4665791B
19 G x 1 1/4 "	1.10 x 30 mm	Lange punt	4000 stuks	4665317B
19 G x 1 1/2 "	1.10 x 40 mm	Lange punt	4000 stuks	4657799B
19 G x 1 1/2 "	1.10 x 40 mm	Korte punt	4000 stuks	4665112B
19 G x 2 "	1.10 x 50 mm	Lange punt	3000 stuks	4665511B
18 G x 1 1/2 "	1.20 x 40 mm	Korte punt	4000 stuks	4665120B
18 G x 1 1/2 "	1.20 x 40 mm	Lange punt	4000 stuks	4650034B
14 G x 3 1/8 "	2.10 x 80mm	Korte punt	2000 stuks	4665473B
18 G x 2	1.20 x 50 mm	Korte punt	3000 stuks	4667123B

Semi-stomp, stompe en filternaalden voor toevoeging

Gebruik van 2-naaldentechniek

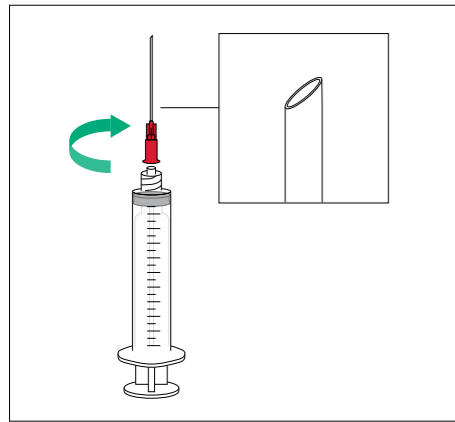

1. Verbind de half-stompe Sterican® MIX-naald met de Luer- of Luer Lock-spuit en verwijder de naalddop.

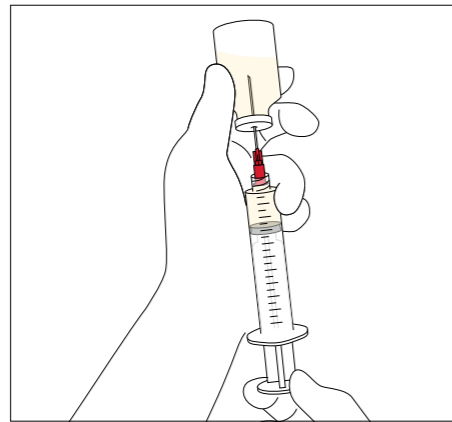

2. Zuig de medicatie uit de flacon op.

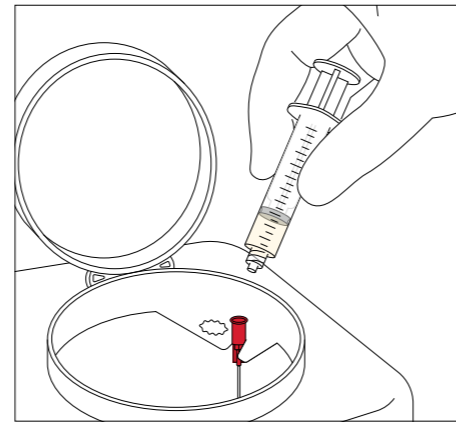

3. Gooi de half-stompe naald weg in de container voor scherpe voorwerpen.

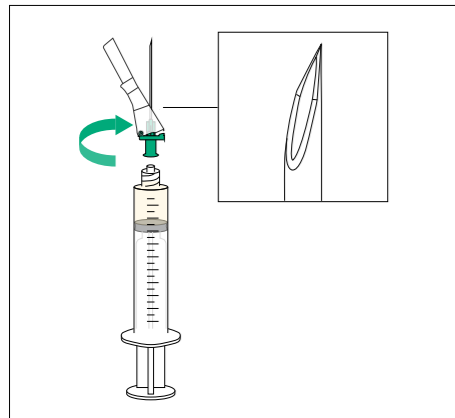

4. Bevestig de Sterican® Safety Needle aan de voorbereide spit (2-naaldentechniek) en verwijder de naalddop.

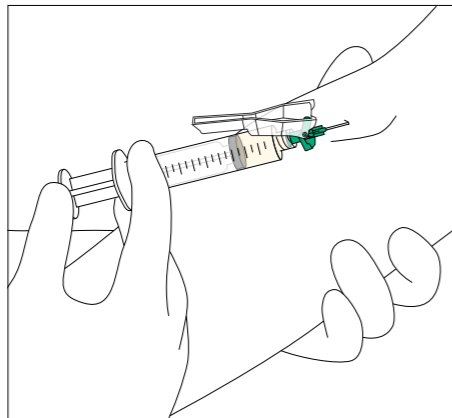

5. Dien de medicatie toe aan de patiënt met de Sterican® Safety Needle.

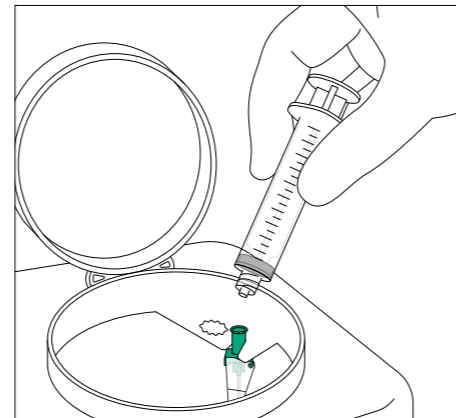

6. Nadat het veiligheidsmechanisme is geactiveerd, gooi je de Sterican® Safety Needle weg in de container voor scherpe voorwerpen.

Sterican®

Naalden

Productomschrijving	Gauge x lengte (inch)	Ø x lengte	Punttype	Punthoek	Eenheid per doos	Referentie-nummer
Sterican® Blunt	27 G x 1 "	0.40 x 25 mm	Stomp	90°	4000 stuks	9180117B
Sterican® Blunt	21 G x 7/8 "	0.80 x 22 mm	Stomp	90°	4000 stuks	9180109B
Sterican® MIX	18 G x 1 1/2 "	1.2 x 40 mm	Semi-stomp	40°	4000 stuks	4550400B
SOL-M™ semi-stompe naald zonder filter	18 G x 1 1/2 "	1.2 x 40 mm	Semi-stomp	45°	100 stuks	110022
SOL-M™ semi-stompe naald zonder filter	18 G x 2 "	1.2 x 50 mm	Semi-stomp	45°	100 stuks	110023
SOL-M™ Blunt 5 µm filternaald	18 G x 1 1/2 "	1.2 x 40 mm	Semi-stomp	45°	100 stuks	110022F
SOL-M™ Blunt 5 µm filternaald	18 G x 2 "	1.2 x 50 mm	Semi-stomp	45°	100 stuks	110023F
Sterifix® filternaald 5 µm	19 G x 1 "	1,1 x 25 mm	Kort	-	50 stuks	4550404
Sterifix® filternaald 5 µm NRFit®	19 G x 1 "	1,1 x 25 mm	Kort	-	50 stuks	4550404N
Aspiratiennaald zonder filter	14 G x 1 1/4 "	2.0 x 30 mm	-	-	100 stuks	8258813
Apiratiennaald met 15 µm partikelfilter	14 G x 1 1/8 "	2.0 x 28 mm	-	-	100 stuks	8258821

Sterican® Safety Needle

Hypodermische veiligheidsnaalden met Luer Lock-connector en puntlengte volgens indicatie

Producteigenschappen

- Gemaakt van roestvrij chroomnikkelstaal
- Transparante Luer Lock plastic naaf gemaakt uit polypropyleen
- Siliconen coating
- Afschuining met drie facetten
- Voldoet aan EU-richtlijn (2010/32/EU)
- Naaf met kleurcodering in overeenstemming met ISO 6009
- Vrij van PCV, latex, DEHP en BPA
- Steriele enkelvoudige verpakking
- Doos van 100 stuks

Gebuikersvoordelen

- Anti-naaldenprikapparaat om het risico van accidentele prikaccidenten te verminderen
- Visuele en hoorbare feedback tijdens de activering van het veiligheidsmechanisme om te bevestigen dat de naald vastzit
- Tot drie haken zorgen voor een veilige vergrendeling van de naald
- Het ontwerp uit één stuk zorgt ervoor dat het veiligheidsschild en de naald stevig vast blijven zitten tijdens het applicatieproces
- Glad oppervlak door fijn gedoseerde siliconencoating
- Kleurgecodeerde naaf voor eenvoudigere identificatie van de buitenste naalddiameter
- Compatibel met alle standaard Luer- en Luer Lock-spuiten



Gauge x lengte (inch)	Ø x lengte	Punttype	Eenheid per doos	Referentienummer
30 G x 1/2 "	0.30 x 13 mm	Lange punt	1000 stuks	4670002S-01
27 G x 1/2 "	0.40 x 13 mm		1000 stuks	4670005S-01
26 G x 1/2 "	0.45 x 13 mm		1000 stuks	4670008S-01
25 G x 5/8 "	0.50 x 16 mm		1000 stuks	4670012S-01
25 G x 1 "	0.50 x 25 mm		1000 stuks	4670016S-01
25 G x 1 1/2 "	0.50 x 40 mm		1000 stuks	4670020S-01
24 G x 1 "	0.55 x 25 mm		1000 stuks	4670022S-01
23 G x 1 "	0.60 x 25 mm		1000 stuks	4670025S-01
23 G x 1 1/4 "	0.60 x 30 mm		1000 stuks	4670027S-01
23 G x 1 1/2 "	0.60 x 40 mm		1000 stuks	4670028S-01
22 G x 1 "	0.70 x 25 mm		1000 stuks	4670030S-01
22 G x 1 1/4 "	0.70 x 30 mm		1000 stuks	4670032S-01
22 G x 1 1/2 "	0.70 x 40 mm		1000 stuks	4670035S-01
21 G x 1 "	0.80 x 25 mm		1000 stuks	4670040S-01
21 G x 1 1/4 "	0.80 x 30 mm		1000 stuks	4670042S-01
21 G x 1 1/2 "	0.80 x 40 mm		1000 stuks	4670045S-01
20 G x 1 "	0.90 x 25 mm		1000 stuks	4670047S-01
20 G x 1 1/2 "	0.90 x 40 mm		1000 stuks	4670050S-01
19 G x 1 1/2 "	1.10 x 40 mm		1000 stuks	4670052S-01
18 G x 1 "	1.20 x 25 mm		1000 stuks	4670053S-01
18 G x 1 1/2 "	1.20 x 40 mm		1000 stuks	4670055S-01



Ontdek meer over
onze infuusaccessoires

B. Braun Medical N.V. | +32 (0)2 712 86 50 | www.bbraun.be

De informatie in deze communicatie is strikt vertrouwelijk, kan bedrijfsinformatie omvatten en is alleen bedoeld voor gebruik door de geadresseerde. Het is eigendom van de afzender van deze informatie. Ongeoorloofd gebruik, openbaarmaking of kopiëren van deze communicatie of een deel daarvan is ten strengste verboden en kan onwettig zijn. De genoemde producten zijn medische hulpmiddelen. Lees voor gebruik altijd eerst de gebruiksaanwijzing.



Milieuvriendelijk drukwerk