



Reducing Risks of Misconnections in Regional Anesthesia

Connecting what belongs together

Medical device connectors for Neuraxial & Regional Anesthesia applications are changing to meet international design standards.

Medication errors during Regional Anesthesia procedures

The universally compatible Luer connector has been identified as a key element in 'wrong route' medication errors. Luer connectors are widely used for delivery of infusions. Literature shows that any patient having multiple access systems in place are exposed to higher risks of misconnections.¹

The increasing sensitivity to medication errors in clinical settings is visible in an increasing number of publications on this subject in Pubmed between 2000 and 2014 (Fig. 1).

FIGURE 1

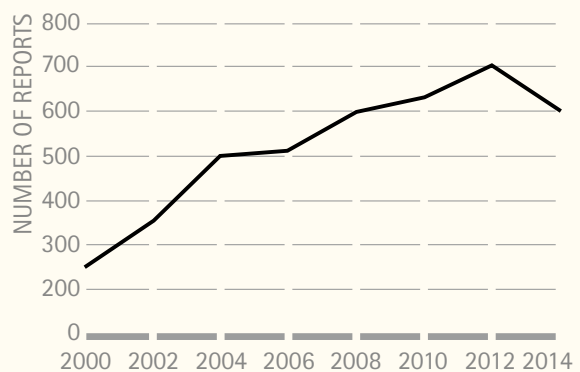

Enhancing patient safety with NRFit®

To reduce the risk of wrong route medication errors the International Organization for Standardization (ISO) has developed standards for small-bore connectors, one being in the field of Neuraxial and Regional Anesthesia (ISO 80369-6). The name that will be used to identify devices that comply with the ISO 80369-6 standard is:

NRFit®

ISO 80369-6 in detail

The ISO Standard 'specifies requirements for small-bore connectors intended to be used for connections in Neuraxial applications. Neuraxial applications involve the use of medical devices intended to administer medications to neuraxial sites, wound infiltration anesthesia delivery, and other Regional Anesthesia procedures or to monitor or remove cerebro-spinal fluid for therapeutic or diagnostic purposes.'²



The International Organization for Standardization (ISO) has identified several medical application areas for which an ISO standard will be developed. These standards are part of the ISO 80369 series. Each standard will provide design and performance specifications for the specific connectors.³

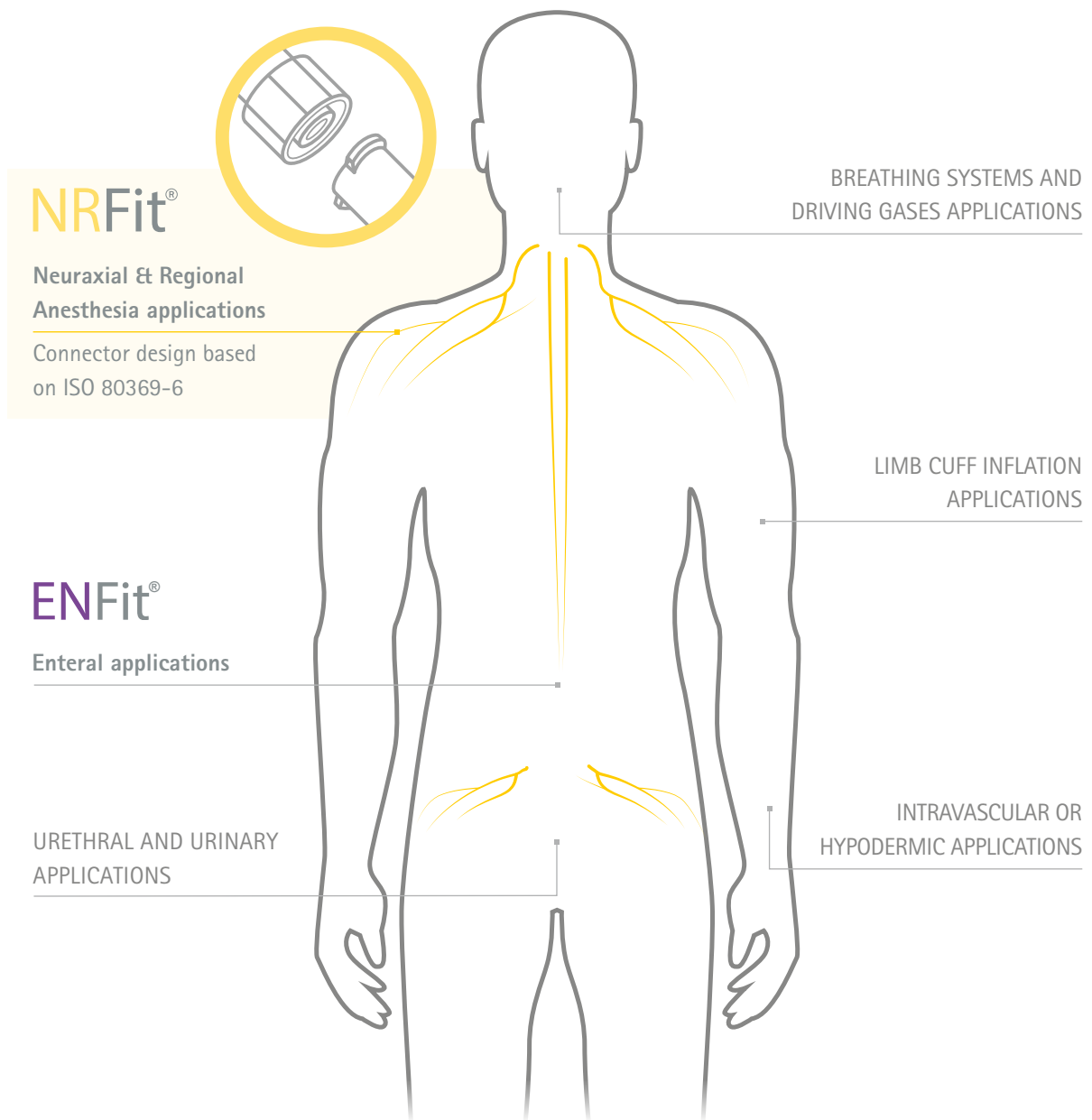

Connector Changes in Regional Anesthesia

And how it impacts your working process

Observe. Listen. Understand. To find solutions that fit into everyday clinical life, B. Braun conducts a vivid dialog with customers. Learning the importance of clear structures, we identified five major steps that represent customary therapy processes. Each of these steps is mapped with aligned products that are dedicated towards improving comfort and achieving a higher level of safety for users and for patients.

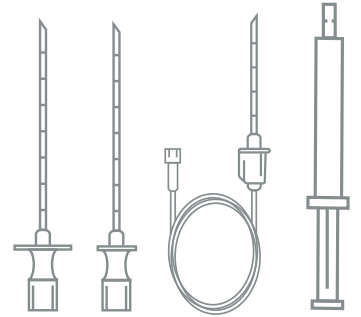

PRESCRIPTION

PATIENT ACCESS

Regional Anesthesia products with NRFit® connector

In line with the ISO Standard for Neuraxial and Regional Anesthesia devices, B. Braun has developed a comprehensive portfolio with NRFit® connectors for the corresponding process steps:

PATIENT ACCESS: Spinal, epidural and PNB needles and LOR syringes

PREPARATION: Filter needles, straws and syringes

APPLICATION: Catheter, syringes, filter, catheter connector, pump disposables



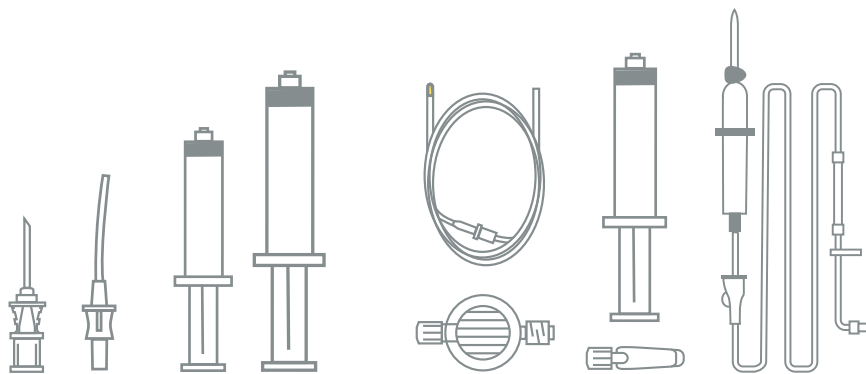

PREPARATION

APPLICATION

DISCHARGE MANAGEMENT

Luer connector

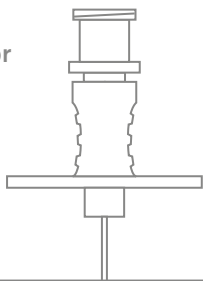

NRFit[®] connector

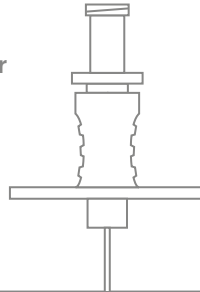

User Benefits

- Dedicated connectors intended to help reduce the risks of misconnections
- 20% smaller in diameter
- Yellow color coding where feasible allows faster identification of Regional Anesthesia devices



B. Braun, as a true **System Partner**, helps to stay on top of evolving standards and their realization across multiple stakeholders, e. g. nurses, pharmacists and anesthetists. With access to our comprehensive product portfolio in Pain Therapy and through constructive dialogue, our partners benefit from B. Braun's know-how and expertise.

Neuraxial Anesthesia with NRFit®

Connecting what belongs together



Therapeutic and anesthetic decisions depend upon a number of factors, including the type and duration of the surgical intervention, patient status and selected postoperative patient management approaches.

Regional Anesthesia can be divided into central and peripheral techniques. When a local anesthetic agent is used next to the spinal cord, this is referred to as Neuraxial Anesthesia. Neuraxial methods include Spinal and Epidural Anesthesia.

Products with NRFit® connector

PATIENT ACCESS: SPINAL ANESTHESIA PRODUCTS

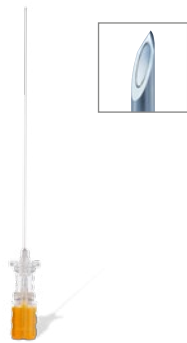

Spinocan®

Spinocan® spinal needles with Quincke bevel provide sharpness for low puncture force. A prism included in the spinal needle hub, supports identification of CSF flashback.



Pencan® and Pencan® Paed

Pencan® spinal needles have an atraumatic Pencil point bevel, which helps reduce PDPH.⁴ They are available in adult and pediatric sizes. A prism included in the spinal needle hub, supports identification of CSF flashback.



PATIENT ACCESS: EPIDURAL ANESTHESIA



Perican®

Perican® epidural needles with Tuohy bevel are available in different sizes. Their polished inner bevel edge helps to reduce the risk of catheter shearing.



PRESCRIPTION

PATIENT ACCESS

PREPARATION

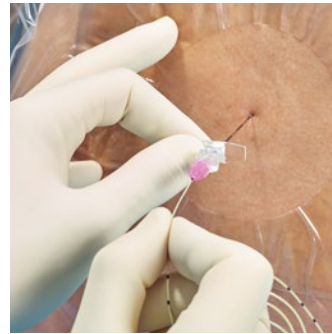

PRODUCTS

APPLICATION: EPIDURAL ANESTHESIA PRODUCTS



Epican® Paed Caudal

Epican® Paed Caudal needles with 45° Crawford type bevel for caudal Pediatric Anesthesia come in three different needle sizes with adjusted depth markings.



Perifix® LOR syringe

Perifix® LOR is a dedicated device for the loss of resistance technique in Epidural Anesthesia. Suitable for air and saline application. Its parabolic graduation helps to differentiate it from conventional syringes.

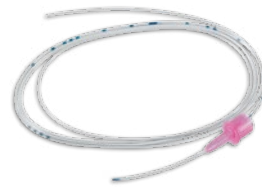

Perifix® catheters

Perifix® catheters for Epidural Anesthesia are available in different versions and types – Standard, Soft Tip and ONE.



Perifix® filter and Perifix® catheter connector

Filters provide an additional degree of safety and control to reduce the risk of bacterial infections. The design of the Perifix® catheter connector and its 'click and ready' mechanism ensure easy use in daily practice.

APPLICATION

DISCHARGE MANAGEMENT

Peripheral Nerve Blocks with NRFit[®]

Connecting what belongs together



Peripheral and Plexus Nerve Blocks are one of the segments of Regional Anesthesia, where a local anesthetic agent is used next to a nerve to provide sensory and motor blockades.

Peripheral nerve blocks can be employed for Anesthesia and for Postoperative Analgesia in order to support early patient mobilization and rehabilitation. PNBs are also used in combination with other forms of Anesthesia and where volatile anesthetics are contraindicated.

Products with NRFit[®] connector

PATIENT ACCESS: SINGLE SHOT PNB PRODUCTS



Stimuplex[®] Ultra 360[®] needles

Stimuplex[®] Ultra 360[®] is designed to perform an ultrasound guided peripheral nerve block and nerve stimulation. Due to high visibility of the X-pattern, the needle is easy to visualize under ultrasound with few artefacts.



Ultraplex[®] 360 needles

Ultraplex[®] 360 is a non-stimulating ultrasound needle, equipped with improved product properties to perform ultrasound guided peripheral nerve blocks, when nerve stimulation is not indicated (e.g. transversus abdominalplane block).



Stimuplex[®] A

Stimuplex[®] A is a single shot unipolar needle, providing the basic nerve stimulation-supported anesthesia for short-term interventions or additional single nerve blocks in continuous techniques.



PRESCRIPTION

PATIENT ACCESS

PREPARATION

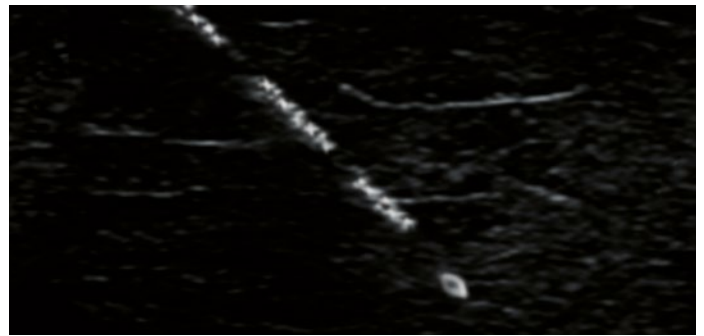

PATIENT ACCESS: CONTINUOUS PNB PRODUCTS



Contiplex® S Ultra 360® needles

Contiplex® S Ultra 360® is a continuous technique needle with a 20° facet bevel, designed to perform ultrasound guided peripheral nerve blocks in combination with nerve stimulation.



Contiplex® Tuohy Ultra 360® needles

Contiplex® Tuohy Ultra 360® is a continuous technique needle with Tuohy bevel, designed to perform ultrasound guided peripheral nerve blocks in combination with nerve stimulation.



Contiplex® C

Contiplex® C is a patented catheter placement system with the innovative catheter-over-needle design. It is designed to help overcome the limitations associated with peripheral catheters, such as complexity of catheter placement, leakage and catheter displacement.

APPLICATION

DISCHARGE MANAGEMENT

Regional Anesthesia Accessories and Complementary Portfolio

Connecting what belongs together

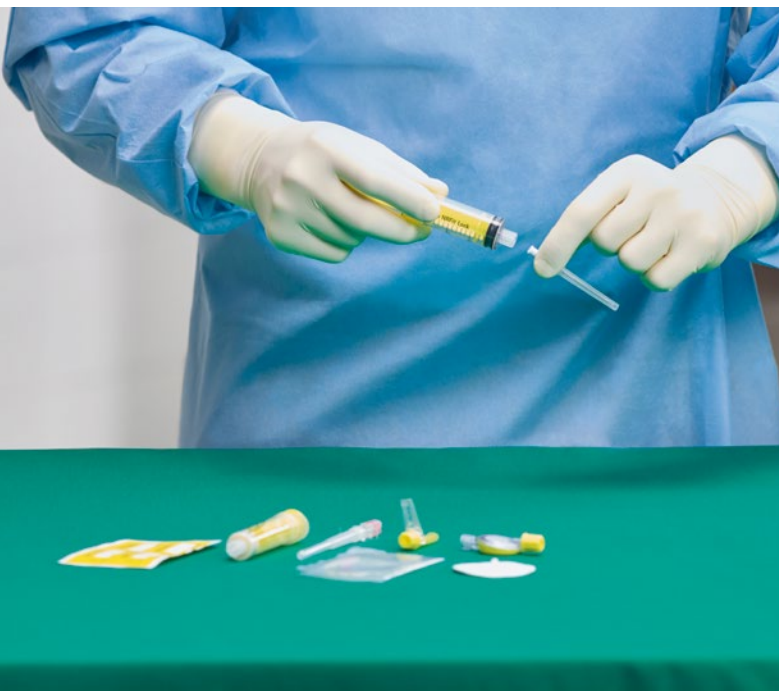

Preparation is a fundamental and irreplaceable part of health care practices. B. Braun preparation devices with NRFit® connectors are designed to reduce risks of wrong route medication errors and particulate contamination from the very beginning in Neuraxial and Regional Anesthesia procedures.



Products with NRFit® connector

PREPARATION: DRAWING-UP DEVICES, FILTER AND CONNECTOR



Sterifix® filter needle

Equipped with a 5 µm filter, Sterifix® filter needle allows for filtering particles during the injection or the withdrawal of medication for Regional Anesthesia.



Sterifix® filter straws

Sterifix® filter straws for Regional Anesthesia with a 5 µm integrated filter allow for the withdrawal of solutions whilst filtering particles.



Perifix® filter

Perifix® filters for Regional Anesthesia are pressure resistant up to 7 bar. In combination with Perifix® PinPad, a self-adhesive fixation device, they can easily be attached to the patient's skin.



Perifix® catheter connector

Perifix® catheter connectors are available in two sizes (19G and 20/24G). A viewing window allows for catheter insertion control to ensure successful connection.

PRESCRIPTION

PATIENT ACCESS

PREPARATION



The method of drug application depends on the chosen technique of anesthesia and on the selected post-OP pain management approach. Different options require dedicated systems. Whether the chosen method of delivery is a bolus or a continuous application, the variety of B. Braun's portfolio ensures flexibility.



The yellow product color coding of syringes and lines helps to visually differentiate between regular and NRFit® dedicated equipment.

Dedicated pump disposables with NRFit® connectors are pressure resistant and suitable for use with compatible electronic pumps.

Products with NRFit® connector

APPLICATION: SYRINGES AND PUMP DISPOSABLES



Omnifix® 1-20 ml

Omnifix® 50 ml

Omnifix® 3-piece syringes are available in a broad portfolio. 3-20 ml lock versions can be used in combination with compatible syringe pumps.

Omnifix® 50 ml syringes with NRFit® lock connector can be used in combination with compatible syringe pumps.



Original Perfusor® Line

The Original Perfusor® Line equipped with the NRFit® connector enables compatibility to NRFit® syringes for pump applications. The translucent yellow tubes help to visually differentiate from other lines.



Infusomat® Space Lines

Dedicated Infusomat® Space Lines have a piercing spike and an NRFit® patient connector. The translucent yellow tubes help to visually differentiate from other lines.

APPLICATION

DISCHARGE MANAGEMENT

Regional Anesthesia Products with NRFit®

Product specifications

SPINAL NEEDLES

Spinocan®	Size (G) / Length (inch)	ø / Length (mm)	Units per box	Code no. (REF)		
	29 x 3 1/2"	0.33 x 88	25	4501900N-01 *		
	27 x 3 1/2"	0.4 x 88		4503902N-01		
	26 x 3 1/2"	0.45 x 88		4502906N-01		
	25 x 3"	0.5 x 75		4505751N-01		
	25 x 3 1/2"	0.5 x 88		4505905N-01		
	22 x 1 1/2"	0.7 x 40		4507401N-01		
	22 x 3"	0.7 x 75		4507754N-01		
	22 x 3 1/2"	0.7 x 88		4507908N-01		
	20 x 3"	0.9 x 75		4509757N-01		
	20 x 3 1/2"	0.9 x 88		4509900N-01		
	19 x 1 1/2"	1.1 x 40		4501144N-01		
	19 x 3 1/2"	1.1 x 88		4501195N-01		
	18 x 3"	1.3 x 75		4501373N-01		
	18 x 3 1/2"	1.3 x 88		4501390N-01		
	Long Length					
	29 x 4 3/4"	0.33 x 120		25	4501918N-01	
27 x 4 3/4"	0.4 x 120	4502140N-01				
26 x 4 3/4"	0.45 x 120	4504917N-01				
25 x 4 3/4"	0.5 x 120	4505913N-01				
22 x 4 3/4"	0.7 x 120	4506090N-01				
22 x 6"	0.9 x 150	4506095N-01				

*With Spinal Introducer Needle

Pencan®	Size (G) / Length (inch)	ø / Length (mm)	Units per box	Code no. (REF)
	27 x 3 1/2"	0.4 x 88	25	4502027N-01
	25 x 3 1/2"	0.5 x 88		4502051N-01 *
	22 x 3 1/2"	0.7 x 88		4502019N-01
				4502043N-01 *
				4502035N-01
Long Length				
27 x 4"	0.4 x 103	25	4502124N-01 *	
27 x 4 3/4"	0.4 x 120		4502132N-01	
25 x 4"	0.5 x 103		4502116N-01 *	
25 x 4 3/4"	0.5 x 120		4502120N-01	
25 x 6.1"	0.5 x 156		333877N-01	

*With Spinal Introducer Needle

SPINAL NEEDLES

Pencan® Paed	Size (G)/ Length (inch)	ø/Length (mm)	Units per box	Code no. (REF)
	27 x 2"	0.4 x 50	25	4502175N-01
	25 x 1"	0.5 x 25		4502167N-01
	25 x 2"	0.5 x 50		4502159N-01

INTRODUCER

Spinal Introducer Needles (for Spinocan® and Pencan®)	Size (G)/ Length (inch)	ø/Length (mm)	Units per box	Code no. (REF)
	For Spinal Needles 29 G and 27 G			
	22 x 1 ³ / ₈ "	0.7 x 35	25	4500059
	For Spinal Needles 26 G and 25 G			
	20 x 1 ³ / ₈ "	0.9 x 35	25	4505000

EPIDURAL NEEDLES

Perican®	Size (G)/ Length (inch)	ø/Length (mm)	Units per box	Code no. (REF)
	18 x 3 ¹ / ₄ "	1.3 x 80	25	4512383N-01
	16 x 3 ¹ / ₄ "	1.7 x 80		4512782N-01
	Long Length			
	18 x 4 ³ / ₄ "	1.3 x 120	25	4512453N-01
	18 x 6"	1.3 x 150		4512200N-01
	16 x 4 ³ / ₄ "	1.7 x 120		4512784N-01
	16 x 4 ³ / ₄ "	1.7 x 120		4512785N-01





Perican® Paed	Size (G)/ Length (inch)	ø/Length (mm)	Units per box	Code no. (REF)
	22 x 2"	0.73 x 50	25	4502078N-01
	20 x 2"	0.9 x 50		4502094N-01
	18 x 2"	1.3 x 50		4502302N-01

Epican® Paed Caudal	Size (G)/ Length (inch)	ø/Length (mm)	Units per box	Code no. (REF)
	25 x 1 ¹ / ₈ "	0.53 x 30	25	4502400N-01
	22 x 1 ³ / ₈ "	0.73 x 35		4502418N-01
	20 x 2"	0.9 x 50		4502426N-01

Regional Anesthesia Products with NRFit®





Product specifications

EPIDURAL CATHETERS





Perifix® catheter	Catheter ø outer/inner/ Length (mm) (G)	Suitable for Perican® Size (G)	Units per box	Code no. (REF)
	Perifix® Standard catheter (with 3 lateral eyes)			
	1.05/0.60/1000 (19)	16	25	4513258N-01
0.85/0.45/1000 (20)	18	4513150N-01		
	Perifix® Standard catheter (with central opening)			
	0.85/0.45/1000 (20)	18	25	4513177N-01
	Perifix® Soft Tip catheter (with 3 lateral eyes)			
	0.85/0.45/1000 (20)	18	25	4515048N-01
	Perifix® ONE catheter (with 6 lateral eyes)			
	1.05/0.60/1000 (19)	16	25	45132581N-01
0.85/0.45/1000 (20)	18	45131501N-01		

Catheter gauge sizes according to EN ISO 9626

ACCESSORIES & COMPLEMENTARY PORTFOLIO

Sterifix® filter straws	Particle filter (µm)	Length (cm)	Units per box	Code no. (REF)
	5	4.5	50	4550250N
	5	10		4550200N
Sterifix® filter needle	Particle filter (µm)	Units per box	Code no. (REF)	
	5	50	4550404N	
Perifix® catheter connector	Size (G)	Units per box	Code no. (REF)	
	19	50	4513801N-01	
	20/24		4513800N-01	
Perifix® filter	Particle filter (µm)	Units per box	Code no. (REF)	
	0.2	25	4515501N-01	

ACCESSORIES & COMPLEMENTARY PORTFOLIO

Infusomat® Space Line	Length (cm)	Units per box	Code no. (REF)
	300	100	8700132SP
Original Perfusor® Line	Length (cm)	Units per box	Code no. (REF)
	200	25	8722865
Omnifix®	Filling volume (ml)	Units per box	Code no. (REF)
	Slip NRFit®		
	1	100	9164001
	3		4616003
	5		4616005
	10		4616014
	20		4616021
	Lock NRFit®		
	3	100	4617003
	5		4617006
	10		4617014
20	4617021		
50	4617508F-01		
Perifix® LOR syringe			Code no. (REF)
	Slip NRFit®		
		25	4637110
	Lock NRFit®		
	25	4638110	







Regional Anesthesia Products with NRFit®

Product specifications

EPIDURAL ANESTHESIA SETS

Legend														
	20 G x 2", ø 0.9 x 50 mm	18 G x 3 1/4", ø 1.3 x 80 mm,	18 G x 2", ø 1.3 x 50 mm (Paed Set)	16 G x 3 1/4", ø 1.7 x 80 mm										
	Perican® Tuohy needle	Perifix® ONE epidural catheter, 6 lateral eyes	Perifix® epidural catheter, 3 lateral eyes	Perifix® Soft Tip epidural catheter, 3 lateral eyes	Perifix® Loss of Resistance syringe	50 mm	80 mm	24 G	20 G	19 G	20 G	19 G	20 G	
Set versions	Perican® with NRFit®	Perifix® ONE with NRFit®	Perifix® Standard with NRFit®	Perifix® Soft Tip with NRFit®	Perifix® LOR with NRFit®									
Complete Sets														
Perifix® 421		■						■						■
Perifix® Soft Tip 901		■							■					■
Perifix® ONE 421		■		■										■
Filter Sets														
Perifix® 400		■						■						
Perifix® 401		■						■						■
Perifix® 402		□							■					■
Perifix® Soft Tip 701		■							■					■
Perifix® Soft Tip 730		□							■					■
Perifix® ONE 401		■		■										■
Perifix® ONE 402		□							■					■
Pediatric Sets														
Perifix® ONE Paed 18	■			■										■
Perifix® ONE Paed 20	■			■										■
Mini Set														
Perifix® 300		■						■						

Catheter gauge sizes according to EN ISO 9626



						<p>* Sterican® needles</p> <p>25 G, 16 mm, ø 0.5 mm 21 G, 40 mm, ø 0.8 mm 18 G, 40 mm, ø 1.2 mm</p>
Omnifix® three part syringe, 20 ml, Lock, Sterifix® filter needle	Omnifix® three part syringe, 3 ml, Lock, Sterifix® filter needle	Perifix® Filter 0.2 µm, pressure resistant up to 7 bar	Perifix® catheter connector 19 G or 20/24 G	Perifix® PinPad filter fixation	Omnifix® three part syringe, 3ml, Luer lock, 3 hypodermic Luer needles * Caution: Product with Luer connection	

Omnifix® and Sterifix® with NRFit®	Omnifix® and Sterifix® with NRFit®	Perifix® Filter with NRFit®	Perifix® catheter connector with NRFit®	Perifix® PinPad	Omnifix® and hypodermic needles with Luer	Units per box	Code No. (REF)
■		■	■	■	■		4514211N-01
■		■	■	■	■	10	4510305N-01
■		■	■	■	■		45142111N-01
		■	■	■			4514009N-01
		■	■	■			4514017N-01
		■	■	■			4514025N-01
		■	■	■		10	4510097N-01
		■	■	■			4517309N-01
		■	■	■			45140171N-01
		■	■	■			45140251N-01
	■	■	■	■		10	45120061N-01
	■	■	■	■			45120141N-01
			■			10	4513002N-01

Regional Anesthesia Products with NRFit®

Product specifications

PNB NEEDLES

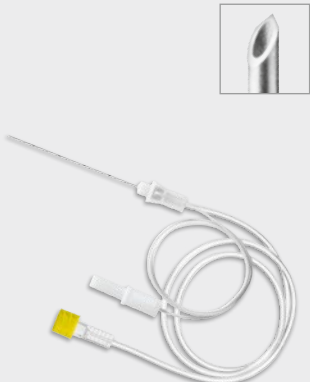
Stimuplex® Ultra 360® needles	Size (G)/ Length (inch)	ø / Length (mm)	Bevel (°)	Units per box	Code No. (REF)
	22 x 1 3/8"	0.70 x 35	30	25	4892503NR
	22 x 2"	0.70 x 50			4892505NR
	22 x 3 1/8"	0.70 x 80			4892508NR
	20 x 4"	0.90 x 100			4892510NR
	20 x 6"	0.90 x 150			4892515NR
Ultraplex® 360 needles	Size (G)/ Length (inch)	ø / Length (mm)	Bevel (°)	Units per box	Code No. (REF)
	22 x 1 3/8"	0.70 x 35	30	25	4892603NR
	22 x 2"	0.70 x 50			4892605NR
	22 x 3 1/8"	0.70 x 80			4892608NR
	20 x 4"	0.90 x 100			4892610NR
	20 x 6"	0.90 x 150			4892615NR
Stimuplex® A needles	Size (G)/ Length (inch)	ø / Length (mm)	Bevel (°)	Units per box	Code No. (REF)
	20 x 6"	0.90 x 150	30	25	4894278NR
	21 x 4"	0.80 x 100			4894260NR
	21 x 2"	0.80 x 50			4894375NR
	22 x 2"	0.70 x 50			4894502NR
	22 x 1 1/8"	0.70 x 35			4894367NR
	22 x 1"	0.70 x 25			4894539NR
	24 x 1"	0.55 x 25			4894251NR

PNB NEEDLES

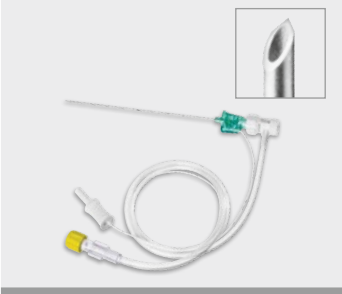
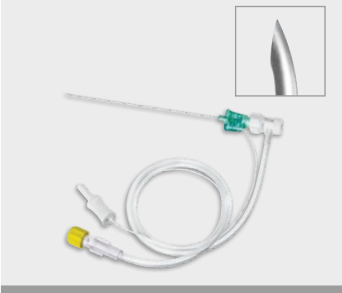
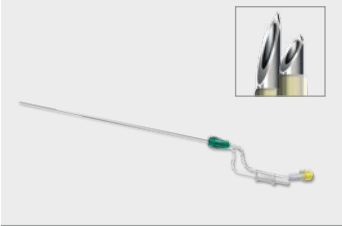
Contiplex® S Ultra 360® needles (incl. side port adapter)	Size (G)/ Length (inch)	ø/Length (mm)	Bevel (°)	Units per box	Code No. (REF)
	18 x 2"	1.30 x 50	20	10	4898650NR-27
	18 x 4"	1.30 x 100			4898610NR-27
	18 x 6"	1.30 x 150			4898615NR-27
Contiplex® Tuohy Ultra 360® needles	Size (G)/ Length (inch)	ø/Length (mm)		Units per box	Code No. (REF)
	18 x 1½"	1.3 x 40		10	4898704NR-01
	18 x 2"	1.3 x 50			4898705NR-01
	18 x 4"	1.3 x 100			4898710NR-01
	18 x 6"	1.3 x 150			4898715NR-01
Contiplex® C needles (incl. extension tube)	Size (G)/ Length (inch)	ø/Length (mm)	Bevel (°)	Units per box	Code No. (REF)
	25 x 7½"	0.53 x 190	15	5	4898115NR
	25 x 7½"	0.53 x 190	30		4898130NR



PNB ACCESSORIES

Contiplex® extension tube	Length (mm)	Units per box	Code no. (REF)
	300	25	4511212NR

Regional Anesthesia Products with NRFit®

Product specifications

PERIPHERAL NERVE BLOCK SETS

					
Contiplex® C catheter over the needle system	Contiplex® S	Contiplex® S Ultra 360®	Contiplex® Tuohy	Contiplex® Tuohy Ultra 360®	Perifix® catheter, 3 lateral eyes
25 G	18 G	18 G	18 G	18 G	

Set versions	Bevel (°)	Cannula Length (mm)	Perifix® Standard with NRFit®
Contiplex® C Sets			
Contiplex® C	15	190	
Contiplex® C	30	190	
Contiplex® S and Contiplex® S Ultra 360® Sets			
Contiplex® S	20	50	■
Contiplex® S	20	100	■
Contiplex® S	20	150	■
Contiplex® S Ultra 360®		50	
Contiplex® S Ultra 360®		100	
Contiplex® S Ultra 360®		150	
Contiplex® Tuohy and Contiplex® Tuohy Ultra 360® Sets			
Contiplex® Tuohy		40	■
Contiplex® Tuohy		50	■
Contiplex® Tuohy		100	■
Contiplex® Tuohy		150	■
Contiplex® Tuohy Ultra 360®		40	
Contiplex® Tuohy Ultra 360®		50	
Contiplex® Tuohy Ultra 360®		100	
Contiplex® Tuohy Ultra 360®		150	

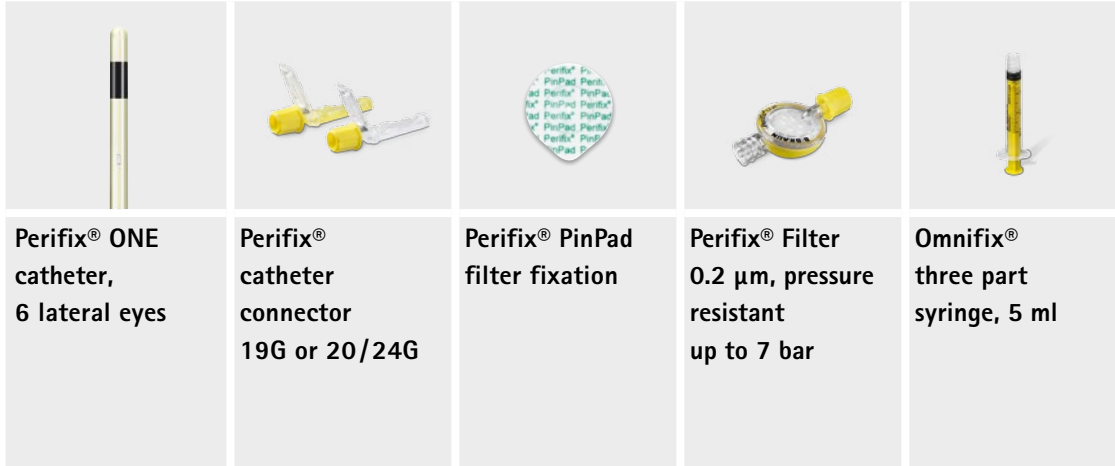

Perifix® ONE catheter, 6 lateral eyes

Perifix® catheter connector 19G or 20/24G

Perifix® PinPad filter fixation

Perifix® Filter 0.2 µm, pressure resistant up to 7 bar

Omnifix® three part syringe, 5 ml

Perifix® ONE with NRFit®	Perifix® catheter connector with NRFit®	Perifix® PinPad	Perifix® Filter with NRFit®	Omnifix® with NRFit®	Units per box	Code No. (REF)
	■	■	■		5	4898115NR
	■	■	■			4898130NR
	■	■	■	■	10	4898405NR
	■	■	■	■		4898410NR
	■	■	■	■		4898415NR
■	■	■	■	■		4898650NR-27
■	■	■	■	■		4898610NR-27
■	■	■	■	■		4898615NR-27
	■	■	■	■	10	4898504NR
	■	■	■	■		4898505NR
	■	■	■	■		4898510NR
	■	■	■	■		4898515NR
■	■	■	■	■		4898704NR-01
■	■	■	■	■		4898705NR-01
■	■	■	■	■	4898710NR-01	
■	■	■	■	■	4898715NR-01	

LITERATURE

1. Kress R, Townley, Jason Lane, Robyn Packer, and Rajnish K. Gupta. Unintentional Infusion of Phenylephrine into the Epidural Space. A&A Case Rep. 2016 Mar 1; 6(5):124-6
2. <https://www.iso.org/standard/50734.html> (2017-05-23)
3. For information please visit: <https://www.iso.org/standard/50734.html>
4. Vallejo MC, Mandell GL, Sabo DP, Ramanathan S. Postdural puncture headache: a randomized comparison of five spinal needles in obstetric patients. Anesth Analg. 2000 Oct; 91(4):916-20

B. Braun Medical B.V. | Tel. +31 (0)412 67 24 11 | customer care.nl@bbraun.com | www.bbBraun.nl
B. Braun Medical N.V./S.A. | Tel. +32 (0)2 712 86 15 | customer care.be@bbraun.com | www.bbBraun.be

NRFit® is a federally registered trademark of GEDSA in multiple jurisdictions throughout the world. Used with permission.
ENFit® is a trademark of GEDSA. Used with permission.